

# PENTAX™

Digital Camera

# Optio 330Gs

## Operating Manual

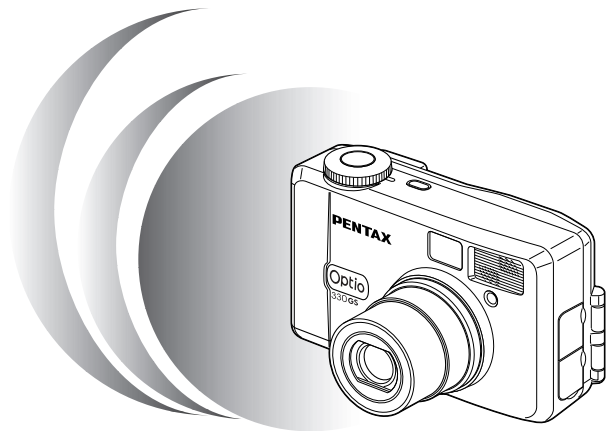

To ensure the best performance from your camera, please read the Operating Manual before using the camera.

Thank you for buying the Pentax Optio 330GS Digital Camera. Please read this manual before using the camera in order to get the most out of all the features and functions. Keep this manual safe, as it can be a valuable tool in helping you to understand all the camera's capabilities.

### **Regarding copyrights**

Images taken using the Optio 330GS that are for anything other than personal enjoyment cannot be used without permission according to the rights as specified in the Copyright Act. Please take care, as there are even cases where limitations are placed on taking pictures even for personal enjoyment during demonstrations, industrial enterprise or as items for display. Images taken with the purpose of obtaining copyrights also cannot be used outside the scope of use of the copyright as laid out in the Copyright Act, and care should be taken here also.

### **Regarding trademarks**

- CompactFlash and CF are trademarks of SanDisk Corporation.
- PENTAX is a trademark of PENTAX Corporation.
- Optio is a trademark of PENTAX Corporation.
- All other brands or product names are trademarks of registered trademarks of their respective companies.
- The USB driver uses software developed by Phoenix Technologies Ltd.
- This product supports PRINT Image Matching II.

When used in combination, PRINT Image Matching II enabled digital still cameras, printers and software help photographers to produce images more faithful to their intentions.

Copyright 2001 Seiko Epson Corporation. All Rights Reserved.

PRINT Image Matching is a trademark of Seiko Epson Corporation.

### **To users of this camera**

- There is a possibility that recorded data may be erased or that the camera may not function correctly when used in surroundings such as installations generating strong electromagnetic radiation or magnetic fields.
- The liquid crystal panel used in the LCD display is manufactured using extremely high precision technology. Although the level of functioning pixels is 99.99% or better, you should be aware that 0.01% or fewer of the pixels may not illuminate or may illuminate when they should not. However, this has no effect on the recorded image.
- There is a possibility that the illustrations and the display screen of the LCD monitor in this manual are different from the actual product.

## FOR SAFE USE OF YOUR CAMERA

Sufficient attention has been paid to the safety of this product but please pay particular attention to the warnings indicated by the following symbols during use.



**Warning** These symbols indicate that it is possible that the user may experience serious difficulties if the warnings are not heeded.



**Caution** These symbols indicate that it is possible that the user may experience minor or middling difficulties or physical difficulties if the warnings are not heeded.



**Warning:**

- Do not attempt to take the camera apart or remodel the camera. High voltages are present within the camera, and there is therefore a danger of electric shocks.
- If the inside of the camera should become exposed as a result of, for example, the camera being dropped, please do not under any circumstances touch such exposed portions, as there is a danger of receiving an electric shock.
- Wrapping the strap of the camera around your neck is also dangerous, and please take care that small children do not hang the strap around their necks.
- Use an AC adapter that are of the power and voltage specified for exclusive use with this product. The use of an AC adapter other than that specified exclusively for use with this product may cause fire or electric shocks.
- If the camera emits smoke or a strange smell, or in the event of any other irregularity, stop using the camera immediately, remove the battery or disconnect the AC adapter and contact your nearest Pentax service center. Continued use of the camera may result in fire or electric shock.
- Discontinue use of the AC adapter during thunderstorms. This can cause a fire or electrical shock.



**Caution:**

- Never try to disassemble, short the battery. Also, do not dispose of the battery in fire, as it may explode.
- Never try to recharge any battery other than the rechargeable NiMH, as this may cause fire or explosion. Among the batteries applicable for Optio 330GS, the NiMH is the only battery that is rechargeable.
- Remove the battery from the camera immediately if it becomes hot or begin to smoke. Be careful not to burn yourself during removal.
- Some portions of the camera heat up during use, so please take care, as there is a risk of low temperature burns if such portions are held for long periods of time.
- If the batteries become old and begin to leak, handle with extreme care.
- If any of the battery leakage should come in contact with your eyes, do not rub them. Flush your eyes with clean water and get medical attention immediately.
- If any of the battery leakage should come in contact with skin or clothes, wash the affected areas thoroughly with water.

## Care to be Taken During Handling

- Do not clean the product with organic solvents such as thinner or alcohol benzene.
- Places of high temperature and humidity should be avoided. Particular care should be taken regarding vehicles, which can become very hot inside.
- Storing the camera where pesticides and chemicals are handled should be avoided. Remove from case and store in a well-ventilated place to prevent the camera from becoming moldy during storage.
- Do not use the camera where it may come in contact with rain, water or any other liquid, because the camera is not weather, water, or liquid resistant. Should the camera get wet from rain, splashing water, or any other liquid, wipe it off immediately with a dry soft cloth.
- Ensure that the camera is not subjected to substantial vibrations, shocks or pressure. Place the camera on a cushion for protection when the camera is subjected to the vibrations of a motorbike, car, or ship, etc.
- The liquid crystal display will become black at temperatures of approximately 60°C (140°F) but will return to normal when normal temperatures are returned to.
- The response speed of the liquid crystal display becomes slow at low temperatures. This is due to the properties of the liquid crystal and is not a fault.
- Remove dust from the lens and viewfinder using a blower or clean off dust using a lens brush.
- Periodic checks are recommended every 1 to 2 years in order to maintain high-performance.
- When the camera has not been used for a long time, confirm that it is still working properly, particularly prior to taking important pictures (such as at a wedding or during travelling). Pentax is not responsible for consequential damages (costs incurred as a result of taking pictures, loss of benefits that were to be obtained through taking pictures) arising from failure of this product.
- If the camera is subjected to rapid temperature changes, condensation may form on the inside and outside of the camera. Therefore put the camera in a bag or plastic bag, and take the camera out when the difference in temperature has subsided.
- The temperature range in which the camera can be used is 0°C to 40°C (32°F to 104°F).
- Avoid contact with garbage, dirt, sand, dust, water, toxic gases, salt, etc. as this may cause damage to the camera. If rain or drops of water get onto the camera, please wipe dry.
- Please refer to "Precautions When Using a CF Card" (p.14) regarding the CompactFlash (CF) card.

FOR SAFE USE OF YOUR CAMERA .....	1
Care to be Taken During Handling .....	2
Contents .....	3
Contents of the Operating Manual .....	5
Checking Contents of the Package .....	6
Name of Parts .....	7
Names of Operating Parts .....	8
<b>Getting Started .....</b>	<b>9</b>
Attaching the Strap .....	9
Powering the Camera .....	10
Inserting the Battery .....	10
Using the AC Adapter (optional) .....	12
Installing or Removing the CF Card .....	13
Turning the Camera On and Off .....	15
Playback Only Mode .....	15
Initial Settings .....	16
Setting the Display Language .....	16
Setting the Home Town .....	17
Setting the D.S.T. Mode .....	17
Setting the Video Output Format .....	18
Setting the Date and Time .....	18
<b>Quick Start .....</b>	<b>20</b>
Taking Still Pictures .....	20
Playing Back Still Pictures .....	22
How to View the Recorded Images .....	24
<b>Common Operations .....</b>	<b>26</b>
Using the Button Functions .....	26
Capture Mode .....	26
Playback Mode .....	28
<b>Taking Pictures .....</b>	<b>28</b>
Setting the Shooting Functions .....	28
Changing the Mode .....	28
Selecting the Focus Mode .....	29
Selecting the Flash Mode .....	31
Setting the Menus .....	32
How to Set the Menus .....	32
Menu List .....	34
Selecting the Recorded Pixels .....	36
Selecting the Quality Levels .....	37
Adjusting the Color Balance according to Lighting (White Balance) .....	38
Changing the AF Area (Focusing Area) .....	40
Setting the Light Metering Range to Determine the Exposure (AE Metering) .....	41
Setting the ISO Speed (ISO Speed) .....	42
Selecting the Color Mode (Color) .....	43
Setting the Instant Review Time (Instant Review) .....	44
Setting the Image Sharpness (Sharpness) .....	45
Setting the Color Saturation (Saturation) .....	46
Setting the Image Contrast (Contrast) .....	47
Displaying Shooting Information (Display Mode) .....	48
Taking Pictures .....	49
Taking Pictures with All the Functions Set (Standard Mode) .....	49
Selecting the Picture Mode According to the Shooting Scene (Picture mode) .....	50
Taking Dark Scenes (Night-Scene Mode) .....	52
Taking Movie Pictures (Movie Picture Mode) .....	53

Taking Stereo Pictures (3D Image Mode) .....	55
Continuous Shooting .....	60
Using the Self-Timer .....	61
Using the Zoom .....	62
Taking a Picture of Yourself (Self-Portrait Mode) .....	64
EV Compensation .....	65
Automatically Changing the Shooting Conditions (Auto bracket) .....	66
Saving the Settings (Memory) .....	68
Saving the Menu Items (Memory) .....	68
<b>Playback/Erasing .....</b>	<b>70</b>
Playing Back Images .....	70
Playing Back Still Pictures .....	70
Zoom Display .....	70
Playing Back Movie Pictures .....	71
Nine-image Display .....	72
Slideshow .....	73
Erasing Images .....	74
Erasing a Single Image .....	74
Erasing All Images .....	75
Protecting Images from Deletion (Protect) .....	76
Viewing Images on a TV .....	77
Setting the Printing Service .....	78
Printing Single Image .....	78
Printing All Images .....	80
Viewing Images with your PC .....	82
About the included software .....	82
System environment .....	82
Installing the software .....	83
Connecting your camera and PC .....	86
Viewing images on your PC .....	87
Disconnecting your camera from your PC .....	88
Viewing Images with your Macintosh .....	90
About the included software .....	90
System environment .....	90
Installing the software .....	91
Connecting the camera and your Macintosh .....	92
Viewing images on your Macintosh .....	93
Disconnecting the camera from your Macintosh .....	93
<b>Settings .....</b>	<b>94</b>
Camera Settings .....	94
Formatting a CF Card .....	94
Setting the Date Style .....	95
Changing the Date/Time .....	96
Changing the Display Language .....	96
Changing the Video Output Format .....	97
Setting the Beep .....	97
Setting the World Time .....	98
Screen Effect .....	99
LCD Power Saving (Sleep Timeout) .....	100
Setting the Brightness Level .....	101
Resetting to Default Settings (Reset) .....	101
<b>Appendix .....</b>	<b>102</b>
List of City Names .....	102
Messages .....	103
Troubleshooting .....	105
Main Specifications .....	108
Optional Accessories .....	110
WARRANTY POLICY .....	111

This Operating manual contains the following chapters.

## ● Getting Started

This chapter explains what you need to do after purchasing the camera before you start taking pictures. Be sure to read it and follow the instructions.

## ● Quick Start

This chapter explains the simplest way to take pictures and play back images. Use it if you want to start taking pictures straightaway. It also tells you how to use the CF card.

## ● Common Operations

This chapter explains common operations such as the functions of the mode dial and buttons, and how to use the menus. For more details, refer to the respective [Taking Pictures], [Playback/Erasing] and [Settings] chapters.

## ● Taking Pictures

This chapter explains the various ways of capturing images and how to set the relevant functions.

## ● Playback/Erasing

This chapter explains how to play back images on the camera or on a TV and how to delete images.





## ● Settings

This chapter explains how to set the camera-related functions.

## ● Appendix

This tells you about the messages displayed on the LCD monitor and what to do in the event of trouble.

The meanings of the symbols used in this Operating manual are explained below.

	indicates the reference page number for an explanation of the related operation.
	indicates information that is useful to know.
	indicates precautions to be taken when operating the camera.
	The icons above the title show the Capture modes, that can activate the function.

## Checking Contents of the Package



Camera  
Optio 330GS

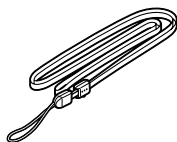

Strap  
O-ST5

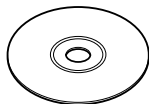

Software (CD-ROM)  
S-SW6



Video cable  
I-VC2



USB cable  
I-USB2

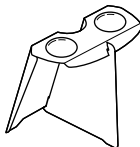

3D Image Viewer  
O-3DV1

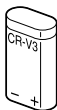

Lithium battery  
CR-V3



Operating Manual  
this manual



## Name of Parts

### Front

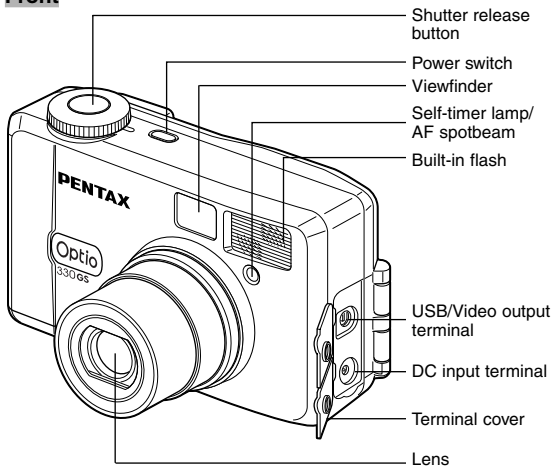

### Back

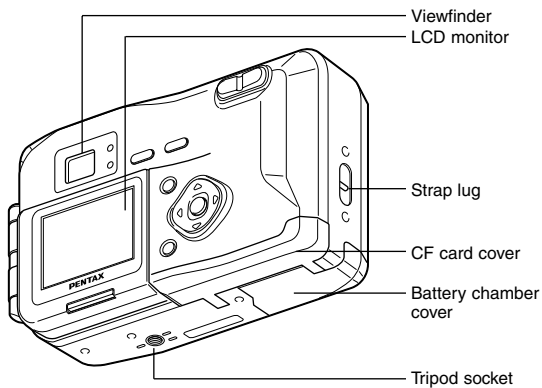

## Names of Operating Parts

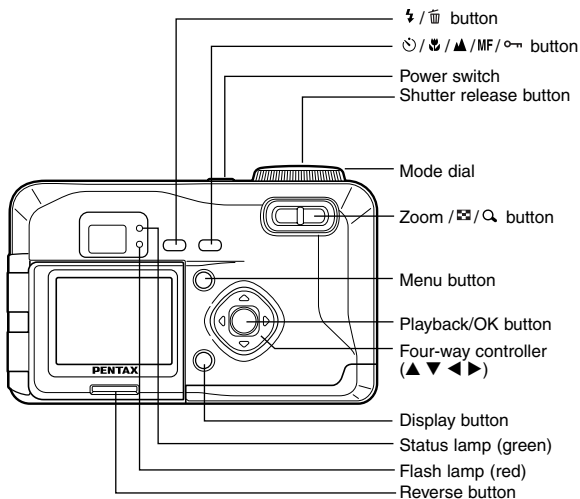

### ● Guide indications

A guide to available button operation is displayed on the LCD monitor during operation. The buttons are indicated as shown below.

Four-way controller (▲)	▲	Zoom / 📷 / Q button (Only for digital zoom and magnified playback)	🔍
Four-way controller (▼)	▼	Display button	DISP
Four-way controller (◀)	◀	🗑️ button	🗑️
Four-way controller (▶)	▶	⌚ button	⌚
Menu button	MENU ↶	Reverse button	↶
Playback/OK button	OK ✓		

## Attaching the Strap

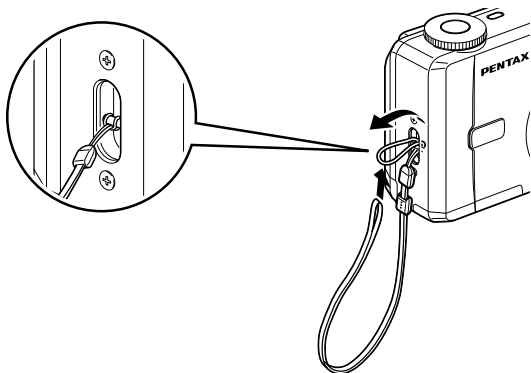

Pass the narrow end of the strap through the strap lug and pass the other end through the loop.

# Powering the Camera

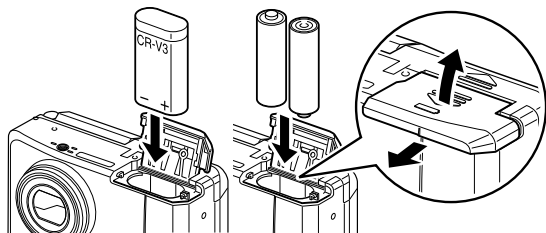

## Inserting the Battery

Insert the battery into the camera. Use two size AA alkaline batteries, two size AA nickel batteries, two size AA nickel hydride batteries, two size AA lithium batteries or one CR-V3 lithium battery pack.

- 1** Slide the battery chamber cover in the direction indicated by arrow and lift it up.
- 2** Insert the battery in the direction indicated by the (+) (-) marks inside the battery chamber.
- 3** Close the battery chamber cover and slide it back into place.



- If you intend to use the camera for a long period, use of the AC adapter D-AC5 (optional) is recommended. (p.12)



- Do not open the battery chamber cover or remove the battery when the camera is turned on.
- If you do not intend to use the camera for a long time, remove the battery.
- If the camera is left without the battery for a long time, the date setting will be reset.
- Insert the battery correctly. If the battery is incorrectly oriented, it may cause a malfunction.

## ● Approximate number of recordable images and playback time (when new batteries are loaded)

	No. of recordable images (With 50% of shooting uses flash LCD monitor ON)	Playback time (minute)
CR-V3	500	240
AA Lithium	350	150
AA NiMH	200	100
AA Nickel	100	60
AA Alkaline	50	30



\* The above table is based on Pentax measuring conditions and may vary depending on capture mode and shooting conditions.

### Caution

Generally, battery performance is temporarily deteriorate as temperature decreases. When the camera is used in a cold environment, keep this product warm by holding it in some protection against cold or inside the clothes. Battery performance once deteriorated due to low temperature will be recovered when the batteries are returned to room temperature.

## ● Battery Level Indicator

You can check the battery level by the  symbol displayed on the LCD monitor.

 (lit green)	: Adequate power remains.
↓	
 (lit yellow)	: Battery is running very low.
↓	
 (lit red)	: Battery is exhausted.
↓	
[Battery depleted]	: After the message is displayed, the camera will turn off.

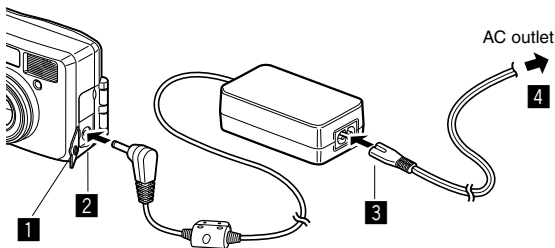

## Using the AC Adapter (optional)

If you intend to use the LCD monitor for a long time or connect the camera to a PC, use of the AC adapter D-AC5 (optional) is recommended.

- 1** Make sure that the camera is turned off and opening the terminal cover.
- 2** Connect the DC terminal on the AC adapter to the DC input terminal on the camera.
- 3** Connect the AC plug cord to the AC adapter.
- 4** Plug the AC plug cord into the power outlet.



- Make sure that the camera is turned off before connecting or disconnecting the AC adapter.
- Make sure that the AC plug cord and connecting cord are inserted securely. If the cord becomes disconnected while you are taking pictures, the data may be lost.
- When using the AC adapter D-AC5, be sure to read the operation manual accompanying the AC adapter.

# Installing or Removing the CF Card

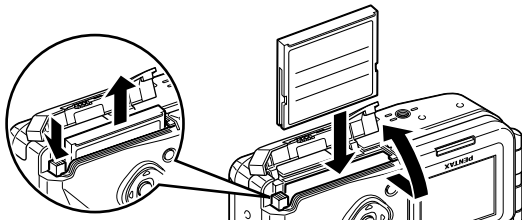

Captured images are recorded on the CompactFlash (CF) card. Make sure that the camera is turned off before inserting or removing the CF card (optional).

## Installing the Card

- 1** Slide the CF card cover in the direction indicated by arrow and lift it up.
- 2** Rotate the card with the surface of the card having the ▲ symbol facing towards the lens and with the pin-connector edge of the card towards the slot and insert fully.
- 3** Close the CF card cover.

## Removing the Card

- 1** Slide the CF card cover in the direction indicated by arrow and lift it up.
- 2** Press the CF card eject button and remove the card.
- 3** Close the CF card cover.



- If you open the CF card cover when the camera is turned on, a warning beep will sound and the camera will be forcibly turned off.
- If you open the CF card cover while recording an image on the CF card, the recording operation will be terminated (the image will not be saved).

## ● Approximate Number of Recordable Images and Recorded pixels/Quality levels

Quality levels Recorded pixels	Best (★★★)	Better (★★)	Good (★)	Movie images (320 × 240)
2048 × 1536	Approx. 8	Approx. 16	Approx. 33	30 sec. × 2 sets
1600 × 1200	Approx. 13	Approx. 27	Approx. 60	
1024 × 768	Approx. 24	Approx. 50	Approx. 89	
640 × 480	Approx. 50	Approx. 89	Approx. 128	

- The above table indicates is the number of images when using a 16MB CF card.
- The above table is based on standard shooting conditions specified by PENTAX and may vary depending on the subject, shooting conditions, capture mode, CF card, etc.

### Precautions When Using a CF Card

- Make sure that the camera is turned off before opening the CF card cover.
- Care should be taken if you remove the CF card immediately after using the camera, as the card may be hot.
- Do not open the CF card cover or turn the camera off while data is being recorded on the card or transferred to PC using USB cable as this may cause the data to be lost or the card to be damaged.
- Do not bend the CF card or subject it to violent impact. Keep it away from water and store away from high temperature.
- Be sure to format unused CF cards or CF cards that have been used on another camera. Refer to "Formatting a CF Card" (p.94) for instructions on formatting.
- Never open the CF card cover during formatting as this may cause the card to be damaged and become unusable.
- The data on the CF card may be erased in the following circumstances. Pentax does not accept any liability for data that is erased
  - when the CF card is mishandled by the user.
  - when the CF card is exposed to static electricity or electrical interference.
  - when the card has not been used for a long time.
  - when the card is ejected, the AC adapter is disconnected or the battery is removed while the data on the card is being accessed.
- The CF card has a limited service life. If it is not used for a long time, the data on the card may become unreadable. Be sure to make a backup of important data on a PC.
- Avoid using or storing the card where it may be exposed to static electricity or electrical interference.
- Avoid using or storing the card in direct sunlight or where it may be exposed to rapid changes in temperature or to condensation.



# Turning the Camera On and Off

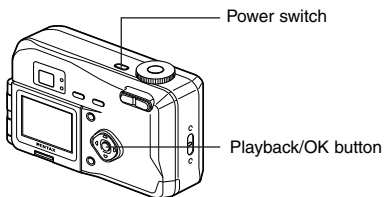

Use the power switch to turn the camera on and off.

## **1** Press the power switch.

The camera will turn on.

When the camera is turned on the lens cover opens and the lens extends.

Press the power switch again to turn the camera off.

## Playback Only Mode

Turning on the camera while pressing Playback/OK button will activate Playback only mode.

- When you turn on the camera in Playback Only Mode, the lens cover remains closed and the lens does not extend.
- You can not change to Capture mode from Playback only mode.

Playing Back Images  p.70

# Initial Settings

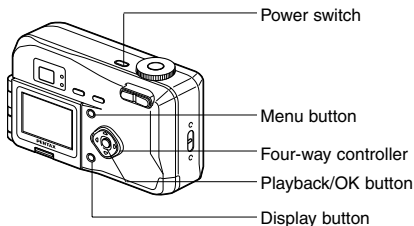

If the initial settings screen appears when you turn the camera on, follow the procedure below to set the display language, Home Town, DST, video output format and current date and time. If the date and time that appear at the bottom right of the LCD monitor when you turn the camera on for the first time is not the current time, follow the instructions for “Changing the Date/Time” (p.96) to set the correct date and time.

## Setting the Display Language

You can choose the language in which the menus, error messages, etc. are displayed from the following: English, French, German, Spanish, Italian and Japanese.

- 1 Turn the camera on.**
- 2 Use the four-way controller (◀▶) to select the display language.**  
The default setting is English.
- 3 Press the four-way controller (▼).**  
The screen for setting the next item will be displayed.

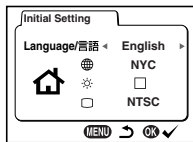

You can change the setting after it has been made. Refer to “Changing the Display Language” (p.96).

## Setting the Home Town

You can choose the city (Home Town) in which you will use the camera.

- 1 Press the four-way controller (◀▶) to select the desired city (Home Town).**
- 2 Press the four-way controller (▼).**  
The screen for setting the next item will be displayed.

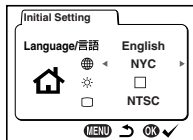

- See p.102 for the list of cities and corresponding code names.
- You can change the setting after it has been made. Refer to “Setting the World Time” (p.98).

## Setting the D.S.T. Mode

You can choose whether or not to display the D.S.T (Daylight Saving Time) mode.

- 1 Use the four-way controller (◀▶) to select  (On) or  (Off).**  
The default setting is  (Off).
- 2 Press the four-way controller (▼).**  
The screen for setting the next item will be displayed.

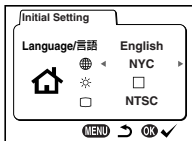

- You can change the setting after it has been made. Refer to “Setting the World Time” (p.98).

## Setting the Video Output Format

You can choose the output format (NTSC or PAL) for taking or playing back pictures using a TV monitor.

- 1 Use the four-way controller (◀▶) to select the video output format.**  
The default setting is NTSC.
- 2 Press the Playback/OK button.**  
The screen for setting the date and time will be displayed.

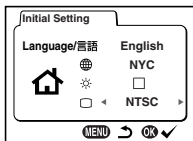

- You can change the setting after it has been made. Refer to “Changing the Video Output Format” (p.97).

## Setting the Date and Time

Set the current date and time.

- 1 Use the four-way controller (▲▼) to change the month.**
- 2 Press the four-way controller (▶).**  
▲ and ▼ will be displayed above and below the day.

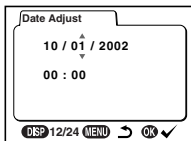
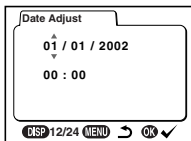

- 3** Use the four-way controller (▲▼) to change the day and press the four-way controller (▶).

▲ and ▼ will be displayed above and below the year.

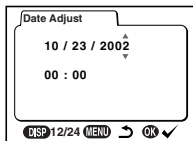

- 4** Repeat Step **3** to change the [year] [hour] and [minutes].

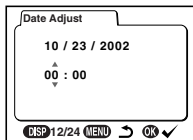

- 5** Use the Display button to select the 12-hour or 24-hour display format.

- 6** When you have finished the settings, press the Playback/OK button when the clock reaches 00 seconds.

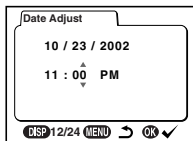

The camera is ready to take a picture.

When you set date and time except the initial settings, press the Playback/OK button again after press the Playback/OK button when the clock reaches 00 seconds to return to capture mode.



- When the initial settings screen is displayed, you can cancel the settings operation and switch to Capture mode by pressing the MENU button. If this is done, the initial settings screen will be displayed next time you turn the camera on.
- You can change the settings after they have been made. Refer to “Changing the Date/Time” (p.96).

## Taking Still Pictures

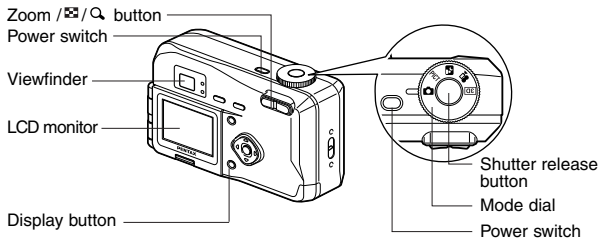

For the simplest procedure to take still pictures:  
The flash fires automatically depending on the light conditions.

- 1 Press the power switch.**  
The camera will turn on.
- 2 Set the mode dial to .**
- 3 Confirm the subject and shooting information on the LCD monitor.**

The focus frame in the middle of the LCD monitor indicates the zone of automatic focusing. You can change the size of the subject by pressing the Zoom button.

 : makes the subject bigger.

 : makes the subject smaller.

You can check the size of the subject by looking through the viewfinder.



Focus Frame



As there is no focus frame in the viewfinder, be sure to check the focusing area on the LCD monitor.

**4 Press the shutter release button.**

The image will be displayed on the LCD monitor for 0.5 seconds (Instant Review) and recorded on the CF card. (The green and red lamps on the right of the viewfinder blink alternately while the image is being recorded on the CF card.)

**Using the Shutter Release Button**

The shutter release button works in a two-step action.

**● Press halfway**

When the shutter release button is pressed lightly (halfway), the focus, exposure and white balance are locked.

The shutter speed and aperture settings are only displayed when the shutter release button is pressed lightly (halfway). You can find the following information on the LCD monitor, the status lamp and the flash lamp.

**① Autofocus frame**

If the subject is in focus, the frame will light green. If the subject is out of focus, the frame will not appear.

**② Focus status lamp & Flash status lamp**

status	Focus status lamp (green)	Flash status lamp (red)
lit	Subject is in focus	Flash is charged
blink	Subject is out of focus	Flash is charging

You cannot take a picture while the flash is charging.

**● Pressed down fully**

The picture is taken.

**Instant Review**

The Instant Review default setting is 0.5 seconds. During this time you can delete the image by pressing the  button (The [Delete] menu will be displayed.), and selecting [Delete], and then pressing the Playback/OK button.

Setting the Instant Review Time  p.44

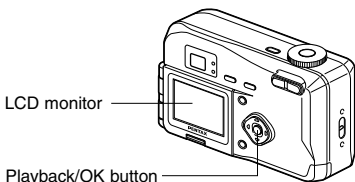

## Playing Back Still Pictures



### Playing Back Images

You can display the still picture.

- 1 Press the Playback/OK button after taking a picture.**

The image taken will be displayed on the LCD monitor. During this time you can erase the image by pressing the  button (The Delete screen will be displayed.), press the four-way controller () to select [Delete], and then pressing the Playback/OK button.

Press the Playback/OK button again or press the shutter release button halfway to return to shooting status.

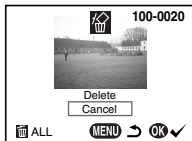

- You can enlarge the image displayed on the LCD monitor by pressing the Zoom  button.
- When the screen is changed to the playback screen, the image with the largest file number will be displayed first.

Zoom Display  p.70



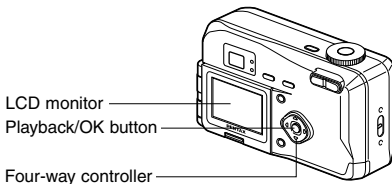

## Playing Back Previous or Next Images

Still images can be played back one at a time, proceeding either forward or backward.

- 1 Press the Playback/OK button after taking a picture.**  
An image will be displayed on the LCD monitor.
- 2 Press the four-way controller (◀▶).**



displays the previous image.



displays the next image.

During this time you can erase the image by pressing the  button (The Delete screen will be displayed.), selecting [Delete], and then pressing the Playback/OK button.

Press the Playback/OK button again or press the shutter release button halfway to return to shooting status.



- In the case of movie pictures, the first frame will be displayed.
- If there are no images stored, the [No image] message will be displayed.

## How to View the Recorded Images

Images taken with the Optio 330GS camera are recorded on the CF card. You can view the images recorded on the card on the camera itself, transfer them to your PC and print them out.



### Viewing images on the camera

One of the advantages of a digital camera is that it enables you to view your pictures immediately after you have taken them. You can check the composition and brightness and take the picture again if you are not satisfied.

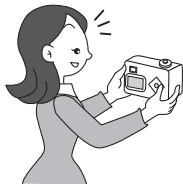

Playing Back Still Pictures  p.22, 70

### Viewing images on a TV

If you want to show your pictures to friends, you can display them on your TV monitor. To view images on your TV, connect the camera to the TV with the video cable.

Viewing Images on a TV  p.77



## Viewing images on a PC

You only need to install the USB driver the first time. After that, you can view recorded images and edit them on the PC just by connecting the camera to the PC with the USB cable and downloading the images. Or you can remove the CF card from the camera and transfer the data to your PC using a card reader. If you use a laptop computer, you can transfer the image data by fitting the CF card into the card adapter and inserting the card adapter into the card slot.

Viewing Images with your PC  p.82

Viewing Images with your Macintosh  p.90



## Printing images by a printing service

Prints of images recorded on the CF card can be ordered in the same way as with conventional photographs by taking the CF card to a store that performs printing.

The number of prints can be specified and dates can be included in the prints if DPOF (Digital Print Order Format) is set before taking the CF card to a store that performs DPOF printing.

Setting the Printing Service  p.78



## Using the Button Functions

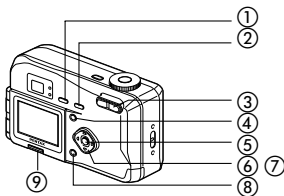

## Capture Mode

- ① **Flash button**  
Changes the flash mode. (☞ p.31)
- ② **Self-timer / Macro / Infinity-landscape / MF button**  
Changes the shooting mode as follows.  
Using the Self-timer (☞ p.61)  
Using macro mode (☞ p.29)  
Infinity-landscape mode (☞ p.29)  
Manual focus (☞ p.30)
- ③ **Zoom button**  
Changes the size of the subject. (☞ p.62)
- ④ **Menu button**  
Displays the active menus in [Rec.Mode] and [Set-up] menu.  
(☞ p.32)
- ⑤ **Playback/OK button**  
Switches to Playback mode.
- ⑥ **Four-way controller (◀▶)**  
Changes the EV compensation in PICT mode.  
(☞ p.65)  
Adjusts the Soft level when [SOFT] is selected in PICT. (☞ p.51)
- ⑦ **Four-way controller (▲▼)**  
Adjusts the focus in MF mode. (☞ p.30)  
Selects Picture mode in PICT. (☞ p.50)
- ⑧ **Display button**  
Changes the information displayed on the LCD monitor. (☞ p.48)
- ⑨ **Reverse button**  
Reverse the image in the LCD monitor from right to left. (The image is not recorded in reverse.) (☞ p.64)

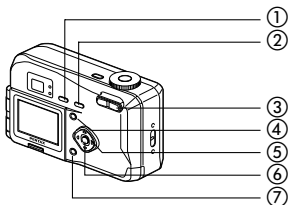

## Playback Mode





- ① **🗑️ button**  
Deletes the image. (☞ p.74)
- ② **🔒 button**  
Protects the image from erasure. (☞ p.76)
- ③ **Zoom / 📐 / Q button**  
- Q + changes the size of the Zoom Display image, displayed on the LCD monitor. (☞ p.62)  
📐 displays nine images at once. (☞ p.72)
- ④ **Menu button**  
Displays the active menus in [Playback] and [Set-up]. (☞ p.32)
- ⑤ **Four-way controller (◀ ▶)**  
Displays images one by one. (☞ p.23)
- ⑥ **Playback/OK button**  
Switches to Capture mode.
- ⑦ **Display button**  
Changes the information displayed on the LCD monitor. (☞ p.48)





# Setting the Shooting Functions

## Changing the Mode

Capture mode is for taking pictures and Playback mode is for playing back or erasing images. Press the Playback/OK button to change the mode between Capture mode and Playback mode. Pressing the shutter release button halfway during Playback mode also moves the camera to Capture mode.

### Selecting the Capture Mode

	Standard mode	All settings can be made at your choice when taking a picture.	p.22, 49
PICT	Picture mode	Settings are made according to the scene you are taking.	p.50
	Night-scene mode	This mode is for taking dark scenes such as night views.	p.52
	Movie picture mode	This mode is for taking moving images.	p.53
	3D image mode	This mode is for taking 3D pictures.	p.55

- 1 Turn the mode dial so that the mark is on  PICT   
 or .
- 2 Press the Playback/OK button or the shutter release button halfway in Playback mode.

### Playback Mode

Playback/ OK button	Playback mode	This mode is for playing back recorded images.	p.70
------------------------	---------------	--	------

- 1 Press the Playback/OK button in Capture mode.

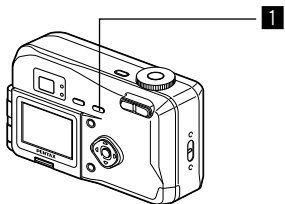

## Selecting the Focus Mode

### ● Focus Mode

(No icon)	Autofocus mode	The camera is focused on the subject in the focusing area when the shutter release button is pressed halfway. Use this mode when the distance to the subject is more than 40cm (1.3ft).
	Macro mode	This mode is used when the distance to the subject is approx. 10cm-50cm (0.33ft-1.64ft). The camera is focused on the subject in the focusing area when the shutter release button is pressed halfway.
	Infinity-landscape mode	This mode is used for taking distant objects.
<b>MF</b>	Manual focus mode	Adjust focus manually by the four-way controller (▲▼).

#### **1** Press the or MF button in Capture mode.

The focus mode changes each time the button is pressed and the setting is displayed on the LCD monitor.

The camera is ready to take the picture in the set focus mode.



- The default setting of the focus mode is [Autofocus mode]. When the focus mode is [Autofocus mode], no icon is displayed on the LCD monitor.
- The MF mode can not be selected in the 3D image mode.
- When the Movie picture mode is selected, the focus mode is set to Autofocus mode.

Using the Self-Timer p.61



If you take a picture while looking through the viewfinder when the focus mode is set on Macro, the range of the resulting picture will differ from what was seen in the viewfinder.  
Be sure to check the image on the LCD monitor.

## Manual Focus

When the mode is set on MF, the center of the picture is enlarged to full screen on the LCD monitor. Adjust the focus with the four-way controller while looking at the image on the monitor. Keep pressing the four-way controller (◀▶) will move the focusing position rapidly.



For distant focus



For closer focus

After the focus is set, press any buttons except the four-way controller (▲▼) or take a finger off from the four-way controller (◀▶). The screen returns to the normal display two seconds later.



- The center of picture is also enlarged in the Digital zoom mode.
- When it is difficult to obtain the correct focus in Manual Focus mode for taking pictures in dark places, press the shutter release button halfway in [Autofocus mode] or [Macro mode], and the AF spotbeam will be emitted, enabling the camera to focus more easily on the subject.

Saving the Focus Mode p.68



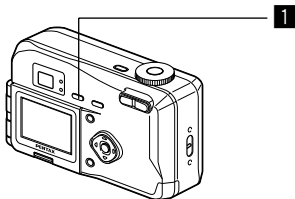

## Selecting the Flash Mode

(No icon)	Auto flash	The flash discharges automatically depending on the light conditions.
	Flash Off	The flash will not discharge, regardless of the brightness.
	Flash On	The flash discharges regardless of the brightness.
	Auto + Red-eye Reduction	This mode reduces the phenomenon of red eyes caused by the light from the flash being reflected in the subject's eyes. The flash discharges automatically.
	Flash On + Red-eye Reduction	This mode reduces the phenomenon of red eyes caused by the light from the flash being reflected in the subject's eyes. The flash will discharge regardless of lighting conditions.



- The flash is off when the Capture mode is set to , continuous shooting, or infinity-landscape mode.
- In [Auto + Red-eye Reduction] and [Flash On + Red-eye Reduction] modes, the flash discharges once to make subject's pupil smaller. And then, take a picture in the flash mode after a brief interval.

### **1** Press the button in Capture mode.

The flash mode changes each time the button is pressed and the set flash mode is displayed on the LCD monitor. The flash lamp blinks red while the flash is charging. If the flash lamp lights red when you press the shutter release button halfway after charging is completed, the camera is ready to take the picture in the set flash mode.

Saving the Flash Mode p.68

# Setting the Menu

When you press the Menu button, the menus are displayed on the LCD monitor. You can set functions, save the settings, and change the camera settings on these menus.

## How to Set the Menu

When you are making settings from a menu, a guide to operation is displayed on the LCD monitor.

- 1 Press the Menu button.**  
The menu screen will be displayed. The selected area will be displayed in a green frame.
- 2 Press the four-way controller (◀ ▶).**  
Use the four-way controller (◀ ▶) to select the menu screen.
- 3 Use the four-way controller (▲ ▼) to select an item.**  
Use the four-way controller (▲ ▼) to move the frame up or down.
- 4 Use the four-way controller (◀ ▶) to change the setting.**
- 4' If there is a Select screen, use the four-way controller (▶) to move to the Select screen.**  
When you have finished making the settings, press the Playback/OK button to return to the menu.
- 5 Press the Playback/OK button.**  
The settings will be saved and the screen will return to capture or playback status.



- If you press any buttons except the Playback/OK button before press the Playback/OK button and leave the menu screen, any changes to setting will not be saved.
- Even if you press the Playback/OK button and leave the menu screen, if you remove the battery before turning off the camera or do not otherwise turn off the camera correctly, any changes to setting will not be saved.

## Example of menu operation

### 1 Menu button

[Rec.Mode] menu

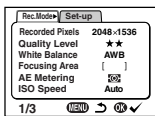

[Set-up] menu



### 2

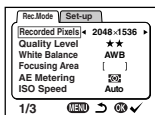

### 3

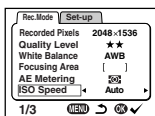

### 4

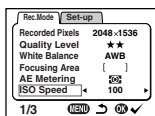

### 3

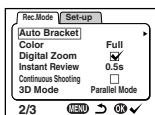

### 4

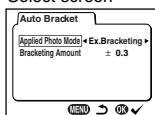

### 3

To the next screen



If you press the shutter release button halfway or press the zoom button to leave the menu screen and move the camera to Capture mode (playback mode in playback only mode), any changes to the setting will not be saved.

## Menu List

### ● [Rec.Mode] Menu

○: Adjustable

×: Fixed at default setting

Item	Description	Default Setting		PICT		Reference
Recorded Pixels	For selecting the size of recorded pixels.	2048 × 1536	○	○	×	p.36
Quality Level	For selecting the image compression rate.	★★	○	○	×	p.37
White Balance	For adjusting the color balance according to lighting.	AWB (Auto)	○	×	○	p.38
Focusing Area	For changing the Area of the autofocus.	[     ] (Wide)	○	○	×	p.40
AE Metering	For setting the metering method to determine the exposure.		○	○	○	p.41
ISO Speed	For setting the ISO speed.	Auto	○	○	×	p.42
Auto Bracket	For setting the shooting conditions such as exposure, saturation and sharpness.	Ex. Bracketing	○	×	×	p.66
Color	For selecting the color mode.	Full	○	×	×	p.43
Digital Zoom	For taking digital zoom pictures.	<input checked="" type="checkbox"/> (On)	○	○	○	p.63
Instant Review	For setting the instant review time.	0.5s (0.5 sec)	○	○	○	p.44
Continuous Shooting	For taking pictures continuously while the shutter release button is pressed.	<input type="checkbox"/> (Off)	○	○	×	p.60
3D Mode	For taking 3-D pictures.	Parallel mode	○	○	×	p.55
Memory	For saving the shooting function settings when the camera is turned off.		○	○	×	p.68
Sharpness	For setting the sharpness.	Normal	○	×	×	p.45
Saturation	For setting the saturation.	Normal	○	×	×	p.46
Contrast	For setting the contrast.	Normal	○	×	×	p.47



Although items [Fixed at default setting] can be changed in the menu, it does not actually affect the camera operation.

## ● [Playback] Menu

Item	Description	Default Setting	Reference
DPOF	For setting the printing service.	–	p.78
Slideshow	Recorded images are played successively.	3s (3 sec. intervals)	p.73

## ● [Set-up] Menu

Item	Description	Default Setting	Reference
Format	For formatting the CF card	Cancel	p.94
Beep	For adjusting the beep sound when a button is pressed	<input checked="" type="checkbox"/> (On)	p.97
Date Style	For setting the date style	Set according to the Language default setting	p.95
Date Adjust	For adjusting the date and time	01/01/2002	p.96
World Time	For setting the world time	<input type="checkbox"/> (Off)	p.98
Language/ 言語	For changing the language in which menus and messages are displayed	English	p.96
Screen Effect	Applies the transition effect (cover left) to the LCD monitor display	<input checked="" type="checkbox"/> (On)	p.99
Video Out	For setting the video output format	Set according to the Language default setting	p.97
Sleep Timeout	For setting the power saving function	1m	p.100
Brightness Level	For setting the brightness of the LCD monitor	Normal	p.101
Reset	For returning the camera settings to defaults	Cancel	p.101

## ● [Memory] menu

This menu is for selecting whether the settings are saved when the camera is turned off.

Refer to p.68 for the items that can be saved.

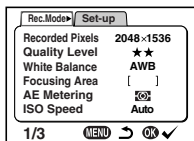
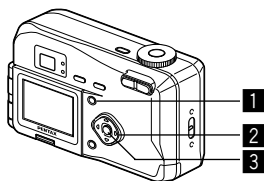

## Selecting the Recorded Pixels

You can choose the number of recorded pixels from [2048 × 1536], [1600 × 1200], [1024 × 768] and [640 × 480].

- 1** Select [Recorded Pixels] on the [Rec.Mode] menu.
- 2** Use the four-way controller (◀ ▶) to change the size.
- 3** Press the Playback/OK button.  
The camera is ready to take the picture.

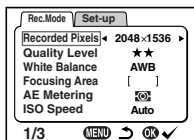

- The recorded pixels is fixed at 320 × 240 pixels in the movie picture mode.

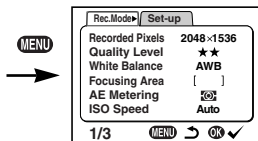
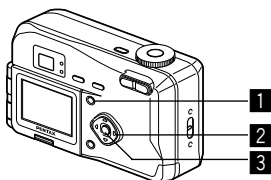

## Selecting the Quality Levels

You can choose the image compression rate.

★★★	BEST	The quality is better and there is a high volume of image data.
★★	BETTER	Standard level
★	GOOD	The quality is good and there is a low volume of image data.

- 1** Select [Quality Level] on the [Rec.Mode] menu.
- 2** Use the four-way controller (◀▶) to change the image quality.
- 3** Press the Playback/OK button.  
The camera is ready to take the picture.

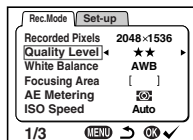

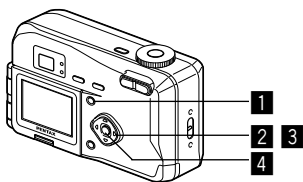

MENU

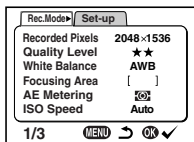

## Adjusting the Color Balance according to Lighting (White Balance)

You can take pictures in natural colors by adjusting the white balance according to the light conditions at the time of shooting.

<b>AWB</b>	Auto	The camera adjusts the white balance automatically.
	Daylight	Use this mode when taking pictures outside in sunlight.
	Shade	Use this mode when taking pictures outside in the shade.
	Tungsten Light	Use this mode when taking pictures under electric or other tungsten light.
	Fluorescent Light	Use this mode when taking pictures under fluorescent light.
	Manual	Use this mode when taking pictures by adjusting the white balance manually.

- 1** Select [White Balance] on the [Rec.Mode] menu.
- 2** Press the four-way controller (▶). The white balance screen will be displayed.
- 3** Use the four-way controller (▲ ▼) to change the setting.
- 4** Press the Playback/OK button twice. The camera is ready to take the picture.

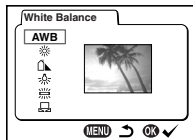

Saving the White Balance p.68



## Manual Setting

- 1** Select [  ] (manual) on the white balance screen.
- 2** Point your camera at a blank sheet of paper so that it fills the screen.
- 3** Press the Display button.  
The white balance is automatically adjusted, [Adjust] is displayed on the LCD monitor and the display returns to the menu screen.
- 4** Press the Playback/OK button.  
The camera is ready to take the picture.

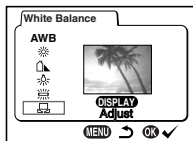

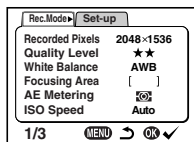
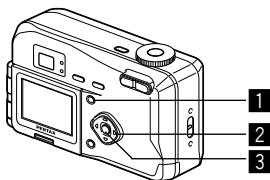

## Changing the AF Area (Focusing Area)

You can change the angle of the autofocus area.

[ ]	Normal range (Wide)
[ ]	The autofocus range becomes smaller. (Spot)

- 1** Select **[Focusing Area]** on the **[Rec.Mode]** menu.
- 2** Use the four-way controller (◀▶) to change the setting.
- 3** Press the **Playback/OK** button.  
The camera is ready to take the picture.

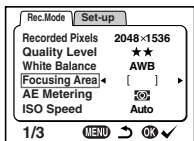

The AF area does not appear in the viewfinder. Always check the focusing area on the LCD monitor.

Saving the AF Area p.68

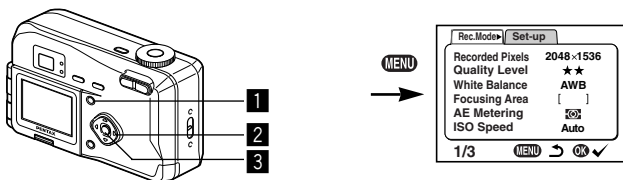

## Setting the Light Metering Range to Determine the Exposure (AE Metering)

You can choose which part of the screen to use to measure the brightness and determine the exposure.

	Multi segment	The exposure is determined by the entire screen.
	Center-weighted	The exposure is determined mainly by the center of the screen.
	Spot	The exposure is determined by the small area in the center of the screen only.

- 1** Select [AE Metering] on the [Rec.Mode] menu.
- 2** Use the four-way controller (◀▶) to change the metering mode.
- 3** Press the Playback/OK button.  
The camera is ready to take the picture.

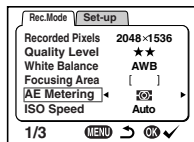

Saving the AE Metering Method p.68

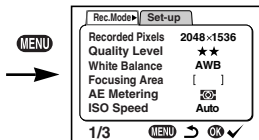
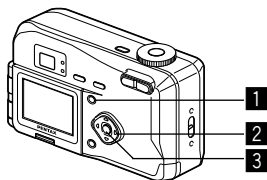

## Setting the ISO Speed (ISO Speed)

You can select the ISO speed to suit the brightness of the surroundings.

### ● ISO Speed

Auto	The camera sets the speed automatically.
100	<ul style="list-style-type: none"> <li>As the lower ISO speed produces sharp images with little or no noise, but the shutter speed will be slower in low light conditions.</li> <li>As the higher ISO speed uses faster shutter speed in low light conditions to reduce camera shake, making the picture blurred.</li> </ul>
200	
400	

- 1** Select [ISO Speed] on the [Rec.Mode] menu.
- 2** Use the four-way controller (◀ ▶) to change the ISO speed.
- 3** Press the Playback/OK button. The camera is ready to take the picture.

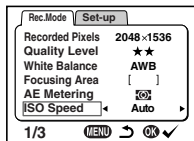

The Auto setting ISO speed is either 100 or 200.

Saving the ISO Speed p.68

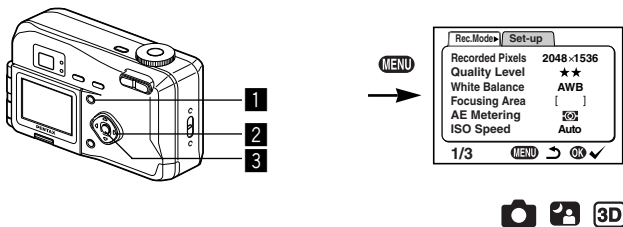

## Selecting the Color Mode (Color)

You can give atmosphere to your pictures by changing the colors to black and white or sepia.

### ● Color Mode

Full	The picture is taken in color.
B & W	The picture is taken in black and white.
Sepia	The picture is taken in sepia.

**1** Select [Color] on the [Rec.Mode] menu.

**2** Use the four-way controller (◀▶) to change the Color mode setting.

**3** Press the Playback/OK button.  
The camera is ready to take the picture.

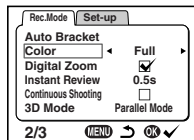

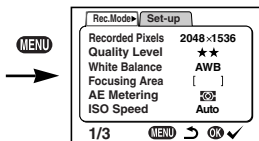
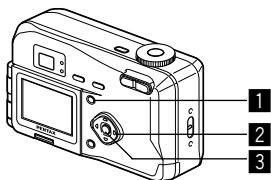

## Setting the Instant Review Time (Instant Review)

You can choose the Instant Review time from 0.5sec., 1sec., 2sec., 3sec., 5sec. or OFF (no display).

- 1** Select [Instant Review] on the [Rec.Mode] menu.
- 2** Use the four-way controller (◀ ▶) to change the display time.
- 3** Press the Playback/OK button.  
The camera is ready to take the picture.

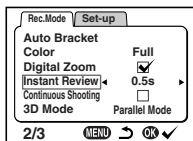

The Instant Review time setting is saved when the camera is turned off.

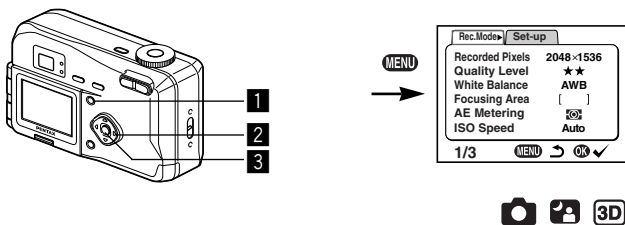

## Setting the Image Sharpness (Sharpness)

You can choose whether you want the image to have sharp or soft outlines.

- 1** Select [Sharpness] on the [Rec.Mode] menu.
- 2** Use the four-way controller (◀▶) to change the setting from [Normal] to [Hard (+)] or [Soft (-)].
- 3** Press the Playback/OK button.  
The camera is ready to take the picture.

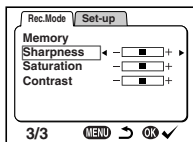

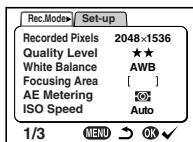
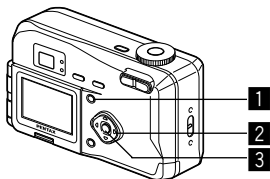

## Setting the Color Saturation (Saturation)

You can set the color saturation.

- 1** Select [Saturation] on the [Rec.Mode] menu.
- 2** Use the four-way controller (◀▶) to change the setting from [Normal] to [Hard (+)] or [Soft (-)].
- 3** Press the Playback/OK button.  
The camera is ready to take the picture.

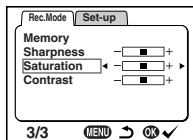



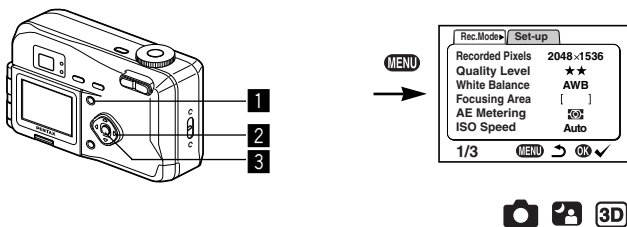

## Setting the Image Contrast (Contrast)

You can set the image contrast.

- 1** Select [Contrast] on the [Rec.Mode] menu.
- 2** Use the four-way controller (◀▶) to change the setting from [Normal] to [Hard (+)] or [Soft (-)].
- 3** Press the Playback/OK button.  
The camera is ready to take the picture.

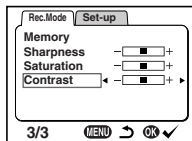

## Displaying Shooting Information (Display Mode)

You can display information on the LCD monitor when shooting. The display mode can be changed by pressing the Display button.

### Display On

Shooting information is displayed.

- ① Flash mode
- ② Shooting mode
- ③ Focus mode
- ④ Capture mode
- ⑤ AF frame
- ⑥ Number of images can be taken
- ⑦ Battery indicator
- ⑧ Date & time

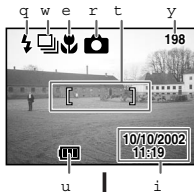

### Histogram Display

The brightness distribution of the image is displayed.

The x-axis shows the brightness (darkest at the left end and brightest at the right end) and the y-axis shows the pixel numbers.

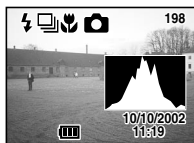

### Display Off

No shooting information is displayed.

- The AF frame in autofocus mode and the battery symbol are displayed.
- If any of the modes are changed such as Flash mode, the mode you have changed is displayed for a few seconds.

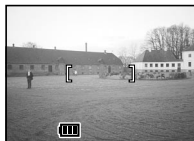

### LCD Monitor Off

The LCD monitor is turned off.

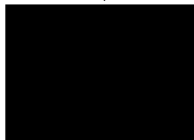

↓  
Display On

Saving the Display Mode  p.68

# Taking Pictures

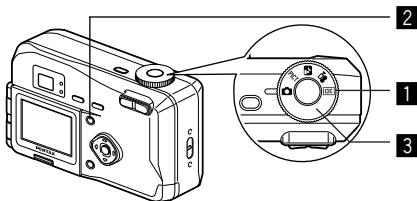

## Taking Pictures with All the Functions Set (Standard Mode)

Set the mode dial to , you can use all of the functions.

- 1 Set the mode dial to .**
- 2 Press the Menu button.**  
The Menu screen will be displayed. For details of how to make the settings, see “How to Use the Menu” (p.32).
- 3 Press the shutter release button.**  
The picture will be taken.

Taking Still Pictures  p.20

When a mode other than [SOFT] is selected.

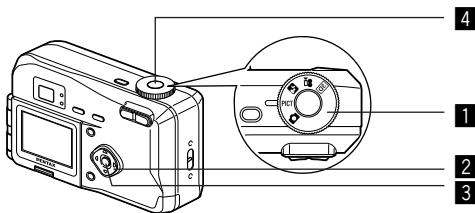

## Selecting the Picture Mode According to the Shooting Scene (Picture mode)

You can select the Picture mode according to the shooting scene.

### Picture mode

There are seven available modes in Picture mode.

	Landscape	Enables to take landscape photos with bright colors.
	Flower	Enables to take flower photos bright in color.
	Portrait	Enables to take portraits with spatial effect, by emphasizing the person.
	Self-portrait	Enables to take clear, beautiful self-portraits and photos which include other people and yourself.
SOFT	Soft	Enables to take portraits and other photos with foggy, soft hues.
	Surf & Snow	Enables to take clear photos at dazzling places like beaches and snow covered mountains.
	Sunset	Enables to reproduce beautiful colors for sunrise and sunset photos.

### ● When the picture mode is selected among from below.



- 1** Set the Mode dial to PICT.
- 2** Press the four-way controller (▼) to display picture modes.
- 3** Press the four-way controller (▲▼) to select the required mode.
- 4** Press the Playback/OK button.  
The mode is selected.
- 5** Press the shutter release button.  
The picture is taken.

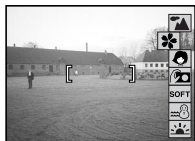

When [SOFT] is selected.

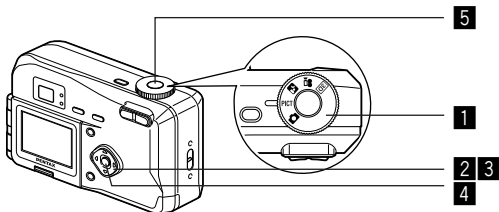

● When [SOFT] is selected

- 1 Set the Mode dial to PICT .
- 2 Press the four-way controller (▲▼) to select the Soft mode.
- 3 Press the four-way controller (◀▶) to adjust the Soft mode level.
- 4 Press the Playback/OK button.  
The soft mode level is set.
- 5 Press the shutter release button.  
The picture is taken.

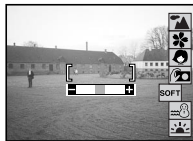

- Picture mode can also be set by pressing the shutter release button halfway, press any buttons except the menu button and the four-way controller, or making no operation for more than five seconds.
- The once set soft mode level is saved in the camera, and it will be still valid next time you take a picture in Soft mode.

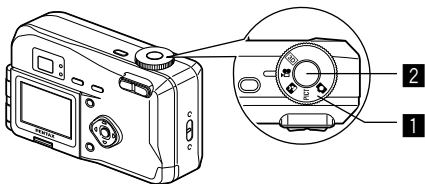

## Taking Dark Scenes (Night-Scene Mode)

The appropriate settings are made automatically for taking dark scenes such as night views.

- 1 Set the mode dial to .**
- 2 Press the shutter release button.**  
The picture will be taken.

Using the Shutter Release Button  p.21  
Playing Back Images  p.22



As the shutter speed becomes slow in night-scene mode, camera shake should be avoided.



It takes time to appear the next shooting screen for reducing noise from the image.

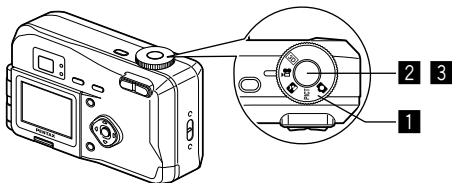

## Taking Movie Pictures (Movie Picture Mode)

This mode enables you to take moving images. The maximum length of one motion picture is approximately 30 seconds. Please mind that sound cannot be recorded.

### 1 Set the mode dial to .

The following information will be displayed on the LCD monitor.



- ① Flash OFF
- ② Remaining shooting time
- ③ Remaining number of sets



### 2 Press the shutter release button.

Shooting will start.

You can change the size of the image using the Zoom button.

-  : makes the image bigger.
-  : makes the image smaller.

### 3 Press the shutter release button.

Shooting will end.

The remaining shooting time will be displayed.

## Keeping the shutter release button pressed

If you keep the shutter release button pressed for more than one second, pictures will be taken for as long as you keep the button pressed. Shooting stops when the button is released.

Playing Back Movie Pictures  p.71



- The flash will not fire in Movie Picture mode.
- The focus mode is set to Autofocus mode in Movie Picture mode.
- Continuous shooting is not possible in Movie Picture mode.
- The LCD monitor cannot be turned off in Movie Picture mode.
- Sound cannot be recorded in Movie Picture mode.



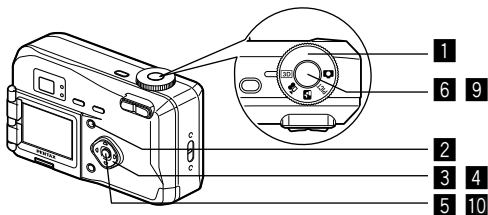

## Taking Stereo Pictures (3D Image Mode)

You can take 3D pictures using the LCD monitor and view them by the parallel method or cross method (p.58). If you print out the 3D pictures and look at them through the 3D image viewer provided, the image will appear in three dimensions.

- 1 Set the Mode dial to  $\text{3D}$ .**  
The LCD monitor screen is divided in two. The left half screen is for taking the first picture.
- 2 Press the Menu button.**  
The [Rec. Mode] menu will be displayed.
- 3 Press the four-way controller ( $\blacktriangle$ / $\blacktriangledown$ ) to select [3D Mode].**
- 4 Use the four-way controller ( $\blacktriangleleft$ / $\blacktriangleright$ ) to select [Parallel Mode] or [Cross Mode].**

To view the picture with the 3D image viewer, select [Parallel Mode].

You can also view it without the image viewer.

- 5 Press the Playback/OK button.**  
The 3D image mode screen appears again.
- 6 Take the first picture while watching the capture guide.**  
Hold the camera so that the subject is in the center of the left half screen, and press the shutter release button. The picture is displayed in the left half screen of the LCD monitor. The right half screen is for taking the second picture.

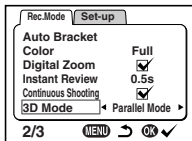

**7** Move the camera to right without changing your stance.

**8** Overlap the images.

On the right side of the screen, the first image will appear in a semi-transparent state on top of the second image. Compose the picture so that the first semi-transparent image is superimposed on the outlines of the second real image.



**9** Press the shutter release button.

The second picture will be taken, and the LCD monitor screen returns to the state described in **5**. If you continue shooting, follow the step described in **6** and afterwards.

**10** Press the Playback/OK button.

The LCD monitor screen displays both the first and second images.



- To cancel the 3D image mode, change the 3D image mode to another Capture mode.
- The display button will not activate in the 3D image mode.
- A clear three-dimensional effect will not be achieved if the two images are taken in widely different positions (heights) or are not straight. When taking a person, you are recommended to ask your model to stay as still as possible and to take the second picture as quickly as you can. It is easier to take the pictures if you use a tripod or appropriate base.
- As a guide, the camera should be moved about  $1/40$  of the distance between the camera and the subject. For example, if the subject is 3m away, the distance the camera should be moved will be  $3\text{m} \div 40 = 7.5\text{cm}$ .

However, as the way people see three-dimensional images differs from person to person, there is no need to be too concerned. Refer to the table below for a simple guide to how far to move the camera.

Distance to subject	0.1 m	0.3 m	0.5 m	1 m	3 m	5 m
Camera movement	0.5 cm	1 cm	1.5 cm	2.5 cm	7.5 cm	13 cm

● Example of a 3D picture



### ● Viewing 3D pictures by the parallel method and cross method

As our eyes are positioned about 6~7cm apart, there is a very slight deviation between what we see with our right eye and what we see with our left eye. The difference is processed by our brain to produce a three-dimensional image. This principle is applied to taking and viewing 3D pictures.

3D pictures can be viewed by the parallel method where the left and right lines of vision are virtually parallel, as when looking at a distant scene, or the cross method where the left and right lines of vision are crossed, as when you cross your eyes. A certain amount of practice may be necessary to view 3D pictures without using the viewer.

### ● How to Assemble the 3D Image Viewer

Assemble the 3D image viewer supplied with the camera as shown below.

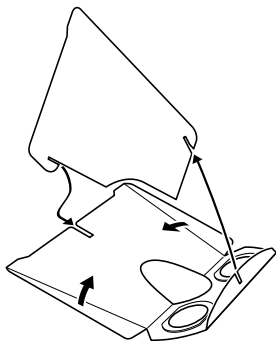

● **How to view 3D pictures using the 3D image viewer**

Print out the pictures so that they are about 11cm or 12cm wide and place the divider of the 3D image viewer in the middle of the two.

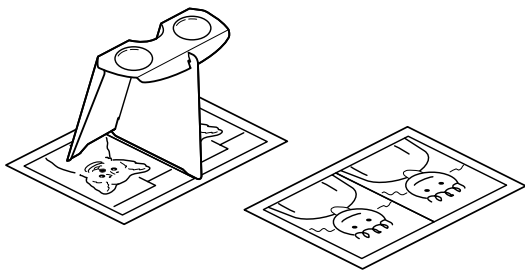

Transfer the images with a PC or Macintosh  p.82 or p.90



As the distance between the left and right eyes differs from person to person, some people may have difficulty obtaining a three-dimensional effect even when looking at prints that are the same size. It may be especially difficult if the pictures are very large or very small. Try different sizes until the right effect is achieved.



- Never look at the sun through the 3D image viewer.
- Do not leave the 3D image viewer where it is exposed to direct sunlight as this may lead to fire.

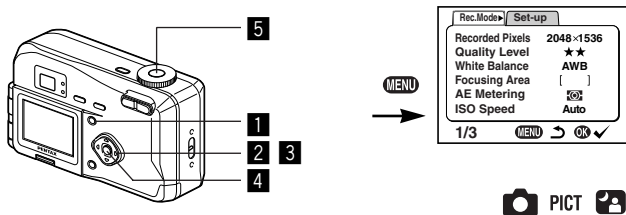

## Continuous Shooting

Pictures are taken continuously while the shutter release button is pressed.

- 1 Press the Menu button in Capture mode.**

The [Rec.Mode] menu will be displayed.

- 2 Press the four-way controller (▲▼) to select [Continuous Shooting].**

- 3 Press the four-way controller (▶) to select  (On).**

- 4 Press the Playback/OK button.**

The  (Continuous Shooting) icon will be displayed on the LCD monitor.

- 5 Press the shutter release button.**

Pictures will be taken continuously while the shutter release button is pressed, and stop when the button is released.

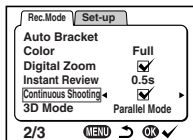

Playing Back Images  p.22



- You can continue shooting until the CF card is full.
- The interval will vary according to the [Recorded Pixels] and [Quality Level] setting.



- The flash will not discharge in Continuous Shooting mode.
- Continuous shooting is not possible in Movie picture mode and 3D Image modes.

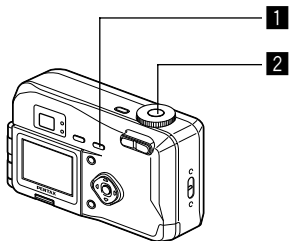

## Using the Self-Timer

The picture will be taken 10 seconds after the shutter release button is pressed.

**1** Press the / / / MF button to display on the LCD monitor.

**2** Press the shutter release button.

The self-timer is engaged and the self-timer lamp lights. The picture is taken approximately three seconds after the self-timer lamp starts to blink.



- If you turn the LCD monitor on, the second count will be displayed.
- If you press the four-way controller, or any buttons such as the Menu button during the second count, the self-timer will be canceled.

Playing Back Images p.22

Taking picture with Self-Portrait Mode p.64

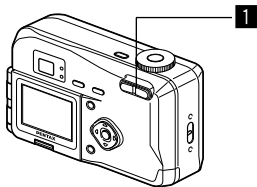

## Using the Zoom

You can use the zoom to take pictures in Tele or Wide mode.

### 1 Press the Zoom button in Capture mode.

▲ : makes the subject larger

▲▲▲ : makes the subject smaller

When the digital zoom function is disabled, you can take pictures at up to 3× magnification using the optical zoom.

When the digital zoom is enabled, you can further enlarge the subject to a maximum magnification equivalent to 8×.

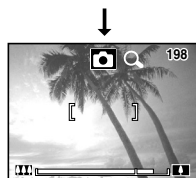
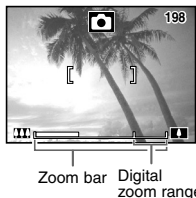



## Enabling the Digital Zoom Function

- 1 Press the Menu button in Capture mode.**  
The [Rec.Mode] menu will be displayed.
- 2 Press the four-way controller (▼) to select [Digital Zoom].**
- 3 Use the four-way controller (▶) to select  (On).**
- 4 Press the Playback/OK button.**  
The camera is ready to take a picture.

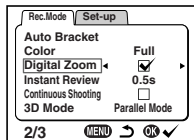

- When you turn the LCD monitor off, the digital zoom is disabled even if the digital zoom function is set to On.

Saving the Digital Zoom Function Setting  p.68

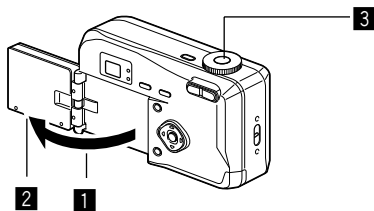

## Taking a Picture of Yourself (Self-Portrait Mode)

You can swing out the LCD monitor, enabling you to see yourself in the monitor when you want to take a picture of yourself or include yourself in the picture.

**1 Turn the LCD monitor over.**

**2 Reverse the image on the LCD monitor.**

When you press the Reverse button,  appears on the LCD monitor and the image displayed in reverse from right to left.

**3 Press the shutter release button.**

The picture is taken.



- The image is not recorded in reverse.
- The menu screen is not reversed.
- If you press the Reverse button without opening the LCD monitor outwards, the image will be reversed on the LCD monitor.
- If you are taking pictures in low light conditions, use the self-timer to avoid camera shake when pressing the shutter release button.

Using the Self-Timer  p.61

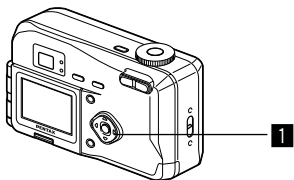

## EV Compensation

You can take pictures that are intentionally overexposed or underexposed.

**1** Press the four-way controller (◀▶) in Capture mode.

- Four-way controller (▶)  
increases the EV compensation  
to a positive (+) level
- Four-way controller (◀)  
decreases the EV  
compensation to a negative (-)  
level



EV compensation level

The set level is displayed on the LCD monitor.



- If you press ◀ or ▶ one time, or set to ± 0, the set level displayed on the LCD monitor will go off after two seconds.

Saving the EV Compensation p.68

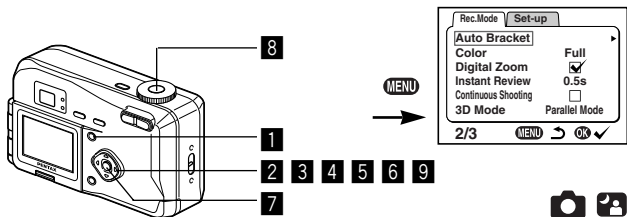

## Automatically Changing the Shooting Conditions (Auto bracket)

You can take three pictures in succession while automatically changing the exposure, white balance, saturation, sharpness and contrast settings.

- 1 Press the Menu button in Capture mode.**  
The [Rec. Mode] menu will be displayed.
- 2 Press the four-way controller (▼) to select [Auto Bracket].**
- 3 Press the four-way controller (►).**  
[Applied Photo Mode] screen to select the bracket setting will be displayed.
- 4 Use the four-way controller (◀►) to select the conditions for bracket shooting.**  
If you selected [Saturation], [Sharpness] or [Contrast], skip step 5, 6 to go to step 7.  
If you selected [Ex. Bracketing] or [White Balance], follow the procedure step 5, 6.
- 5 Press the four-way controller (▼) to select [Bracketing Amount].**
- 6 Use the four-way controller (◀►) to set the bracketing steps.**  
In addition to normal setting, you can take 2 more pictures in steps using a plus and minus settings.

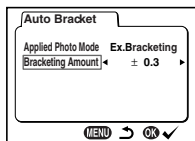
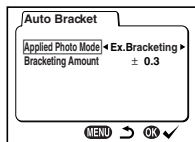

**7 Press the Playback/OK button.**

The Bracket mode is set. The auto bracket icon is displayed on the LCD monitor.

**8 Press the shutter release button.**

Three pictures will be taken continuously, and then return to normal shooting mode.



- Check the pictures you have taken using the Playback mode.
- If you set auto bracket when you set the Continuous shooting mode, continuous shooting will be canceled.
- The auto bracket setting will be canceled by pressing the Menu button or Playback/OK button.

Playing Back Images  p.22

# Saving the Settings (Memory)

## Saving the Menu Items (Memory)

You can choose whether you want the set values to be saved when the camera is turned off. If you select  (On), the settings will be saved in the status they were in immediately before the camera was turned off. If you select  (Off), the settings will be reset to the defaults when the camera is turned off.

Item	Description	Default Setting
Flash	The flash mode setting on the  button is saved.	<input checked="" type="checkbox"/>
EV Compensation	The set EV compensation value is saved.	<input type="checkbox"/>
White Balance	The [White Balance] setting on the [Rec.Mode] menu is saved.	<input type="checkbox"/>
Focusing Area	The [Focusing Area] setting on the [Rec.Mode] menu is saved.	<input type="checkbox"/>
AE Metering	The [AE Metering] setting on the [Rec.Mode] menu is saved.	<input type="checkbox"/>
ISO Speed	The [ISO Speed] setting on the [Rec.Mode] menu is saved.	<input type="checkbox"/>
Digital Zoom	The [Digital Zoom] setting on the [Rec.Mode] menu is saved.	<input checked="" type="checkbox"/>
Focus Mode	The focus mode setting is saved.	<input type="checkbox"/>
Zoom Position	The zoom position setting is saved.	<input type="checkbox"/>
DISPLAY	The LCD monitor display mode is saved.	<input type="checkbox"/>
File #	The file number is saved. If a new CF card is inserted, the sequential file number is assigned.	<input checked="" type="checkbox"/>



Menu items not included in [Memory] will also be saved in the settings selected on the menus for each function when the camera is turned off.

- 1** Press the Menu button in Capture mode.
- 2** Press the four-way controller (▲▼) to select [Memory].
- 3** Press the four-way controller (▶). [Memory] menu will be displayed.
- 4** Use the four-way controller (▲ ▼) to select the item.
- 5** Use the four-way controller (◀ ▶) to switch  (On) and  (Off).
- 6** Press the Playback/OK button twice.

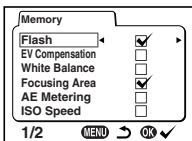
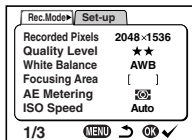

The camera is ready to take the picture.

# Playing Back Images

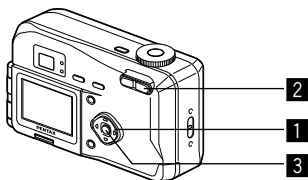



## Playing Back Still Pictures

See “Playing Back Images” (p.22), or “Playing Back Previous or Next Images” (p.23).

## Zoom Display

You can display images magnified up to twelve times. A guide to operation is displayed on the LCD monitor during magnification.

**1** Enter the Playback mode and choose the image you want to magnify with the four-way controller (◀▶).

**2** Press  on the Zoom button.  
The image will be magnified (1× to 12×). If you keep pressing () , the magnification of image will be changed continuously.

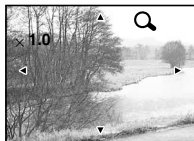



● The following operations can be performed while the magnified image is displayed.

Four-way controller (▲▼◀▶)

Moves the position to be magnified

Zoom /  /  button ()

Makes the image larger

Zoom /  /  button ()

Makes the image smaller

Display button

Turns the guide marks on/off

**3** Press the Playback/OK button.

Zoom playback will end.



Movie pictures cannot be magnified.



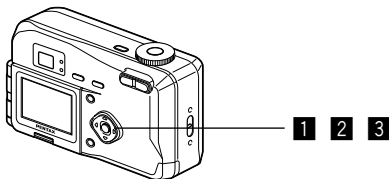

## Playing Back Movie Pictures

You can play back Movie pictures. A guide to operation is displayed on the LCD monitor during playback.

**1** Enter the Playback mode and choose the movie picture you want to play back with the four-way controller (◀▶).

**2** Press the four-way controller (▲). Playback will start.

● The following operations can be performed during playback.

Four-way controller (◀): Reverse playback

Four-way controller (▶): Forward playback

Four-way controller (▲): Pause

Display button: Changes the Display mode

● The following operations can be performed while Pause is engaged.

Four-way controller (◀): Frame reverse

Four-way controller (▶): Frame forward

Four-way controller (▲): Releases the Pause function

Display button: Changes the Display mode

**3** Press the four-way controller (▼). Movie playback will end.



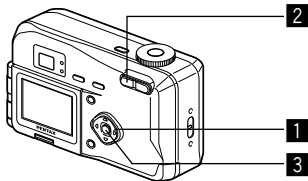



## Nine-image Display

You can display nine images at the same time.

**1** Enter the Playback mode and choose an image with the four-way controller (◀ ▶).

**2** Press  on the Zoom button .

Nine images will be displayed with the selected image in the center. Choose an image with the four-way controller (▲ ▼ ◀ ▶).

When 10 or more images have been recorded, the previous 9 images will be displayed if you press the four-way controller (◀) while an image on the left row is selected. If you press the four-way controller (▶) while an image on the right row is selected, next 9 images will be displayed.



Selected image

**3** Press  on the Zoom button .

The screen will return to single-image display of the selected image.

**4** Press the Playback/OK button.

The camera is ready to take a picture.



For movie pictures, the first frame will be displayed.

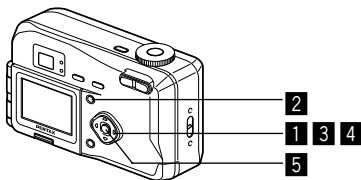

## Slideshow

You can play back all the images on the CF card continuously.

- 1** Enter the Playback mode and choose the image with which to start the slideshow with the four-way controller (◀▶).
- 2** Press the Menu button.  
The [Playback] menu will be displayed.
- 3** Select [Slideshow] with the four-way controller (▼).
- 4** Use the four-way controller (◀▶) to change the playback interval.  
Choose from the following: 3s (3 sec), 5s (5 sec), 10s (10 sec), 15s (15 sec), 20s (20 sec), 30s (30 sec).
- 5** Press the Playback/OK button.  
Playback will start at the set interval.

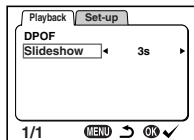

- If you press the four-way controller, or any buttons such as the Menu button during continuous playback, the slideshow will stop.
- The slideshow will continue until you press any button.
- In the case of movie pictures, when one movie picture has been played through, the next movie picture will be played regardless of the set playback interval.

# Erasing Images

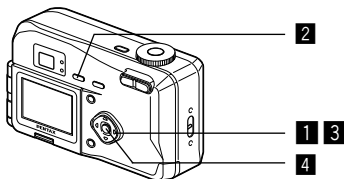

## Erasing a Single Image

- 1** Enter the Playback mode and choose the image you want to erase with the four-way controller (◀▶).
- 2** Press the button. The Delete screen will be displayed.
- 3** Select [Delete] with the four-way controller (▲).
- 4** Press the Playback/OK button.

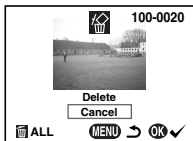

- You can also delete images from Instant Review (p.44).
- You cannot erase protected images (with the symbol).

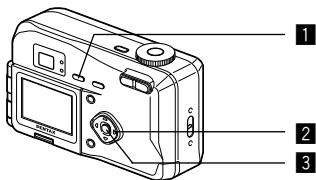



## Erasing All Images

You can erase all the images at once.



- Once erased, images cannot be restored.
- Protected images cannot be erased.

- 1** Enter the Playback mode and press the  button twice. The Delete (All) screen will be displayed.
- 2** Select [Delete All] with the four-way controller ().
- 3** Press the Playback/OK button.

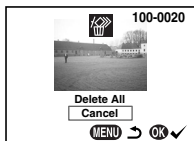

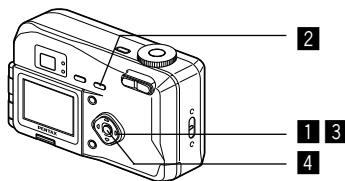



## Protecting Images from Deletion (Protect)

You can protect images from being accidentally erased.

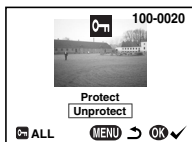
- 1** Enter the Playback mode and choose the image you want to protect with the four-way controller (◀▶).
- 2** Press the  button. The Protect screen will be displayed.
- 3** Select [Protect] with the four-way controller (▲).
- 4** Press the Playback/OK button.



- Select [Unprotect] in step **3** above to release the Protect setting.
- If the image is protected, the  symbol is displayed when the image is played back.

## Protecting All Images

You can protect all the images.

- 1** Enter the Playback mode.
- 2** Press the  button twice. The Protect all screen will be displayed.
- 3** Select [Protect All] with the four-way controller (▲).
- 4** Press the Playback/OK button.



- Even protected images will be erased by formatting the CF card.

# Viewing Images on a TV

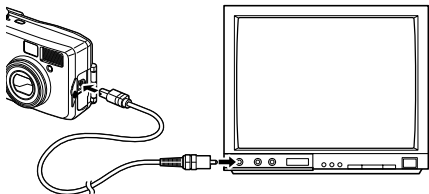

By using the video cable, you can capture and play back images on a TV or other equipment with a video IN jack. Make sure that both the TV and the camera are turned off before connecting the cable.

- 1** Open the terminal cover and connect the video cable.
- 2** Connect the other end of the video cable to the image input terminal of the TV.
- 3** Turn the TV and camera on.

Changing the Video Output Format  p.97



The LCD monitor is always turned off when the camera is connected to a TV.

If you intend to use the camera for a long time, use of the AC adapter (optional) is recommended. Refer to the operating manual for the TV or equipment to which the camera is connected.

# Setting the Printing Service

You can print the images on the CF card using a DPOF (Digital Print Order Format) compatible printer or at a printing service.

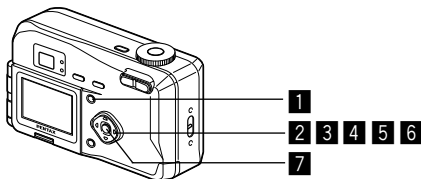

## Printing Single Image

Set the following items for each image.

- **Copies**  
Set the number of prints up to a maximum of 99.
- **Date**  
Specify whether you want the date imprinted on the print or not.

- 1 Press the Menu button in Playback mode.**  
The [Playback] menu will be displayed.
- 2 Select [DPOF] on the menu with the four-way controller (▼).**  
The DPOF setting screen will be displayed.
- 3 Press the four-way controller (▶).**
- 4 Use the four-way controller (◀ ▶) to choose the image for which you want to specify the number of prints and press the four-way controller (▼).**  
The frame will move to [Copies].

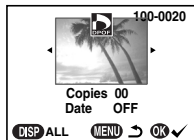



- 5** Use the four-way controller (◀▶) to select the number of prints and press the four-way controller (▼). The frame will move to [Date].

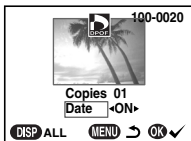

- 6** Use the four-way controller (◀▶) to select [ON] or [OFF].

ON: The date will be imprinted

OFF: The date will not be imprinted

If you want to set more than one image, return to setp **4** for next image.

- 7** Press the Playback/OK button.  
Prints can be made according to the settings.



If DPOF settings have already been made for an image, the previously set number of prints and On/Off date setting will be displayed.



- You cannot set the printing service for movie pictures.
- Depending on the printer or printing equipment at the photo processing lab., the date may not be imprinted on the pictures even if the DPOF setting was made.

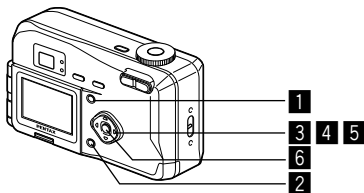

## Printing All Images

- 1** Press the Menu button in playback mode and select [DPOF] on the [Playback] menu.
- 2** Press the four-way controller (▶) and press the Display button. [All Images] will be displayed.
- 3** Use the four-way controller (◀▶) to select the number of prints. You can specify up to 99 prints.
- 4** Press the four-way controller (▼). The frame will move to [Date].
- 5** Use the four-way controller (◀▶) to select [ON] or [OFF].
  - ON: The date will be imprinted
  - OFF: The date will not be imprinted
- 6** Press the Playback/OK button. Prints can be made according to the settings.

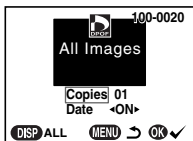

- The setting for a single image will be cancelled.
- When you specify the number of prints in the DPOF setting, the number applies to all the images. Before printing, check that the number is correct.
- The setting is not possible for movie pictures.

# MEMO

# Viewing Images with your PC

By using the provided USB cable (I-USB2) or card reader and image-browser software, you can transfer images recorded with the camera to your PC and edit them or print them out.

This section explains how to view images on your PC using the provided USB driver and software.

## About the included software

The included CD-ROM (S-SW6) contains the following software:

- USB driver
- Image viewing software (ACDSee™)
- Print layout software (FotoSlate™)

## System environment

OS: Windows 98/98 SE/2000/Me  
Windows XP Home Edition/Professional

CPU: Pentium or later recommended

Memory: 64MB or more

Hard disk space: 15MB or more

To view movie pictures on your PC, Direct X 8.0 or later and Media Player pre-installed on system, or QuickTime 3.0 or later are required. For Windows Me/XP, Media Player pre-installed on system, QuickTime 3.0 or later is required.



- Not compatible with Windows 95/NT.
- When you connect the camera to your PC, you are recommended to use the AC adapter.  
If the battery power runs out while image data is being transferred, the data may be lost.

## Installing the software

The procedures for installing the necessary software are explained.

**Caution**

- If you are using Windows 2000 or Windows XP (Professional), Please Login as an administrator user before starting installation.  
Refer to your PC's operating manual for instructions on how to login.

### Installing the USB drivers on Windows 98 /98SE /ME, Widows 2000, XP

- 1 Turn on your computer**
- 2 Insert the CD-ROM (S-SW6) into your CD-ROM drive.**  
The title screen will appear on your desktop.  
If it will not automatically begin the software installation when you first insert the CD-ROM. Double click the [My Computer] → [CD-ROM] → [Setup. exe] application icon to begin the installation process.
- 3 Double click your applicable language.**  
You can choose the language from the following:  
English, French, German, Spanish, Italian and Japanese.
- 4 Click the [USB Driver] on the Master Installer screen.**  
The InstallShield Wizard screen will appear.  
Follow the instruction on the screen.  
Complete InstallShield Wizard screen will appear.

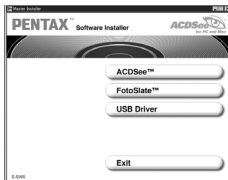

- 5** Click [Next] and then click [Finish].
- 6** Reboot your computer after close the screen.
- 7** Turn your camera off and plug the USB cable into your camera and into an available USB port on your computer.  
Make sure that the CF card in the camera.

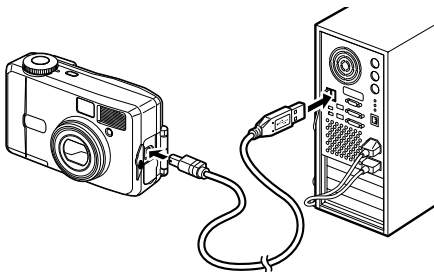

**8** Turn your camera on.

Your computer will automatically detect the camera as new hardware and window will display a notification confirming [Hardware Found : PENTAX OPTIO 330G] (Windows XP) or [Search for the best driver for your device (Recommended)] (Windows 98/98SE/ME/2000) in the task bar recognized area to begin the installation.

When the installation is completed, your camera can then be found in the [My Computer] window as [Removable Disk].

Make sure that "Removable Disk" is displayed in the [My computer] window.



- In the case of Windows XP, if the CF card has a volume label attached, the content of the volume label will be displayed instead of [Removable Disk].  
If the CF card is new and has not been formatted, the manufacturer and capacity of the card will be displayed.

## Installing the ACDSee™

When installing the ACDSee™, recorded images can be viewed on your PC.

- 1 Turn on your computer.**
- 2 Insert the CD-ROM (S-SW6) into your CD-ROM drive.**  
The title screen will appear on your desktop.  
If it will not automatically begin the software installation when you first insert the CD-ROM. Double click the [Setup.exe] application icon to begin the installation process.
- 3 Double click your applicable language.**  
You can choose the language from the following: English, French, German, Spanish, Italian and Japanese.
- 4 Click the [ACDSee™].**  
The Setup screen will appear. Follow the on-screen guidance and enter the registration information.
- 5 When the installation is completed, reboot your computer.**

## Connecting your camera and PC

- 1 Turn on your computer.
- 2 Turn your camera off, and Plug the USB cable into your camera and into an available USB port on your computer. Make sure that the CF card in the camera.

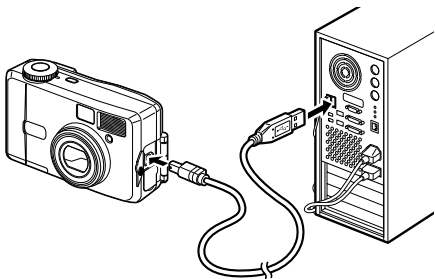

- 3 Turn your camera on.
- 4 Double click the [My Computer].  
Your camera can then be found in the [ My Computer] window as [Removable Disk].

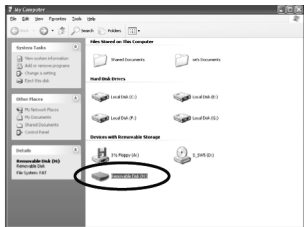

- Although images can be viewed and printed, image data is on the CF card in the camera.  
To save the image data on the CF card to another medium, refer to the instruction manual of your PC and move or copy files using Explorer, etc.
- You can edit images on your PC after moving or copying files there.
- In the case of Windows XP, if the CF card has a volume label attached, the content of the volume label will be displayed instead of [Removable Disk]. If the CF card is new and has not been formatted, the manufacturer and capacity of the card will be displayed.



## Viewing images on your PC

**1** Double click the [ACDSee™] icon on the desktop.

**2** Select an image you wish to view.

Camera images can be found in [My Computer].→  
[Removable Disk (or the name on the volume label on  
the CF card, if there is one)]. [DCIM]. [xxxPENTX] (xxx is  
a 3 digit numeral) folder.

## Disconnecting your camera from your PC

### Disconnecting the camera from your PC (Windows 2000)

- 1** Double click the [Unplug or eject hardware] icon in the task bar recognized area. The [Remove Hardware] screen will appear.
- 2** Make sure [PENTAX USB Disk Device] is selected and click [Stop]. [Stop Hardware Device] screen will appear.



- 3** Make sure [PENTAX USB Disk Device] is selected and click [OK]. A message will appear.



- 4** Click [OK].
- 5** Turn off the camera and disconnect the USB cable from your computer and camera.



For Windows 98/98SE/Me, there is no Hot Plug icon. When removing the camera, turn off the camera and disconnect the USB cable.

## Disconnecting your camera from your PC (Windows XP)

- 1 Click the [Safely Remove Hardware] icon in the task bar recognized area.
- 2 Make sure [PENTAX USB Disk Device] is selected and click [Stop].



- 3 Make sure [PENTAX USB Disk Device] is selected and click [OK].



- 4 A message confirming removal of the hardware will appear. Turn off the camera and disconnect the USB cable from your computer and camera.

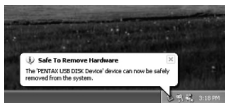

# Viewing Images with your Macintosh

By using the provided USB cable (I-USB2) or card reader and image-browser software, you can transfer images recorded with the camera to your Macintosh and edit them or print them out. This section explains how to view images on your Macintosh using the provided USB driver and software.

## About the included software

The included CD-ROM (S-SW6) contains the following software:

- USB driver
- Image viewing software (ACDSee™)

## System environment

OS: Mac OS 8.6 or later (QuickTime 4.0 or later required)

CPU: Power PC 266MHz or higher

Memory: 8MB or more

Hard disk space: 6MB or more

Standard equipped USB port



- When you connect the camera to your Macintosh, you are recommended to use the AC adapter. If the battery power runs out while image data is being transferred, the data may be lost.

## Installing the software

### Installing the USB Driver and the ACDSee™ on your Macintosh

The procedures for installing the necessary software are explained.

Many current and recent Macintosh computers will automatically recognize the camera and load their own USB mass storage drivers. When you attach the camera to your Mac, the camera should automatically appear on your desktop as an “untitled” disk drive, which you can double click to access.

If you have a USB capable with Mac OS 8.6, you may need to install the USB driver from CD-ROM.

- 1 Turn on your Macintosh.**
- 2 Insert the CD-ROM (S-SW6) into your Mac's CD-ROM drive.**

- 3 Double click the [CD-ROM (S-SW6)].**

The title screen will appear on your desktop.

- 4 Double Click the [Master Installer].**

[Master Installer (Alias)] screen will appear.

If you have a USB capable with Mac OS 9.0 or later, you may skip step 5.

- 5 Double Click the [Master Installer (Alias)].**
- 6 Double click the applicable language folder.**

- 7-a If you install the USB Driver (Mac 8.6 only) Click the [USB Driver].**

The installation of the USB driver will complete.

- 7-b If you install the ACDSee™ (All Mac OS) Click the [ACDSee™].**

Follow the on-screen guidance and enter the registration information and proceed with the installation.

- 8 Reboot your Macintosh.**



## Connecting the camera and your Macintosh

- 1 Turn on your Macintosh.
- 2 Turn off your camera and plug the USB cable into your camera and into an available USB port on your Macintosh.

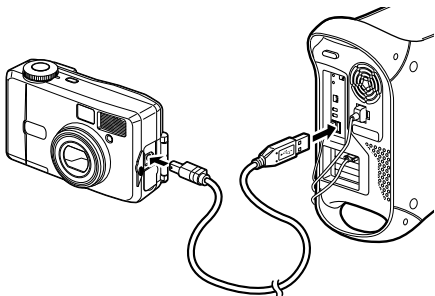

- 3 Turn on your camera.  
The camera will be detected as [untitled] on the desktop. The folder name can be changed as desired.



- Although images can be viewed and printed, image data is in the CF card in the camera. To save the image data in the CF card to another medium, refer to the instruction manual of your Macintosh and move or copy files.
- You can edit images on your Macintosh after moving or copying files there.
- If the CF card has a volume label attached, the content of the volume label will be displayed instead of [Removable Disk]. If the CF card is new and has not been formatted, the manufacturer and capacity of the card will be displayed.

## Viewing images on your Macintosh

- 1** Double click the [ACDSee™] folder on the hard drive.
- 2** Double click the [ACDSee™] program icon.
- 3** Select an image you wish to view.

Camera images can be found in the [untitled]→ [DCIM] →[xxxPENTX] (xxx is a 3-digit numeral) folder on the desktop.



- You can also view movie pictures operating the above procedures.
- If the CF card has a volume label attached, the content of the volume label will be displayed instead of [Removable Disk]. If the CF card is new and has not been formatted, the manufacturer and capacity of the card will be displayed.

## Disconnecting the camera from your Macintosh

- 1** Drag the [untitled (or the name on the volume label on the CF card, if there is one)] folder on the desktop to Trash.
- 2** Turn off the camera and disconnect the the USB cable from your Macintosh and camera.

# Camera Settings

## How to recall [Set-up] menu

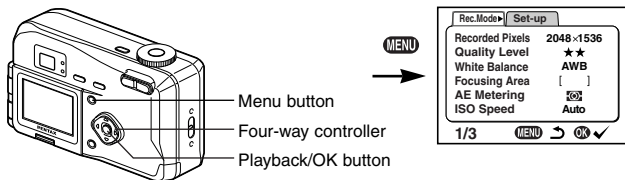

## Formatting a CF Card

Formatting will delete all the data on the CF card.



- Do not open the CF card cover while the card is being formatted. The card may be damaged and become unusable.
- Formatting will delete protected data too.

- 1 Select [Format] on the [Set-up] menu.**
- 2 Press the four-way controller (▶).**  
The Format screen will be displayed.
- 3 Select [Format] with the four-way controller (▲).**
- 4 Press the Playback/OK button.**  
Formatting will start. When formatting is completed, the camera is ready to capture or play back images.



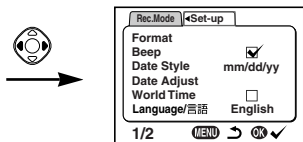

## Setting the Date Style

You can set the style in which the date is displayed on the camera. Choose [mm/dd/yy], [dd/mm/yy] or [yy/mm/dd].

- 1** Select [Date Style] on the [Set-up] menu.
- 2** Use the four-way controller (◀▶) to change the date style.
- 3** Press the Playback/OK button.

The camera is ready to capture or play back images with the selected date style.

## How to recall the [Set-up] menu

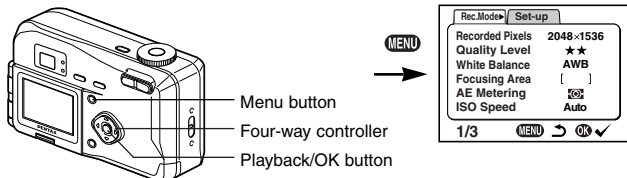

## Changing the Date/Time

You can change the initial date and time settings.

- 1 Select [Date Adjust] on the [Set-up] menu.**
- 2 Press the four-way controller (▶).**  
The date screen will be displayed.

See “Setting the Date and Time” (p.18) for the setting procedure.

## Changing the Display Language

You can change the language in which the menus, error messages, etc. are displayed.

- 1 Select [Language] on the [Set-up] menu.**
- 2 Press the four-way controller (▶).**  
The language setting screen will be displayed.
- 3 Use the four-way controller (▲ ▼) to select the language.**
- 4 Press the Playback/OK button.**  
The menus will be displayed in selected language.
- 5 Press the Playback/OK button.**  
The camera is ready to take or play back images.

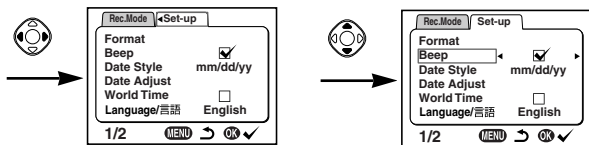

## Changing the Video Output Format

You can select the output format (NTSC or PAL) for taking or playing back images on a TV monitor.

- 1** Select [Video Out] on the [Set-up] menu.
- 2** Use the four-way controller (◀ ▶) to change the video output format.
- 3** Press the Playback/OK button.

The camera is ready to take or play back images.

## Setting the Beep

The beep sound can be turned on and off.

- 1** Select [Beep] on the [Set-up] menu.
- 2** Use the four-way controller (◀ ▶) to select  (On) or  (Off).
- 3** Press the Playback/OK button.

The camera is ready to take or play back images.

## How to recall the [Set-up] menu

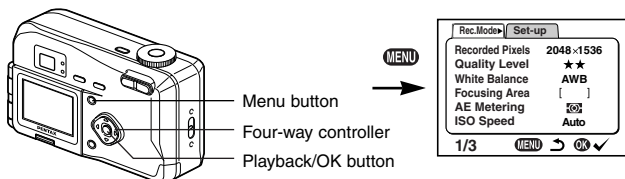

## Setting the World Time

The city and time selected in “Initial Settings” (p.16) serve as the Home Time setting.

You can display the time in a city other than the Home Time city (World Time) when shooting or playing back.

- 1 Select [World Time] on the [Set-up] menu.**
- 2 Press the four-way controller (▶).**  
The World Time screen will be displayed.
- 3 Switch  (On) and  (Off) with the four-way controller (◀▶).**

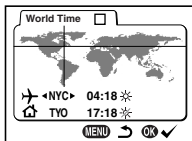

- : The time in the country selected in World Time will be displayed.
- : The time in the country selected in Home Time will be displayed.

- 4 Press the four-way controller (▼).**  
First, New York is selected as the world time city, then the location of New York lights up and blinks on the world map, and then ✈ indicates the current time in New York (NYC).
- 5 Use the four-way controller (◀▶) to select the World Time city and press the four-way controller (▼).**  
◀▶ on the LCD monitor will move to (✈).

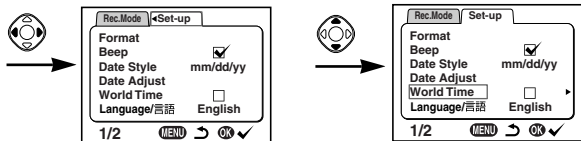

- 6** Select [DST] On (☀) or Off (☁) with the four-way controller (◀▶) and press the four-way controller (▼).  
 ◀▶ on the LCD monitor will move to [🏠] (home time city).  
 Use the four-way controller (◀▶) to change the Home Time city and DST setting.
- 7** Press the Playback/OK button twice.  
 The camera is ready to capture or play back images with the time in the selected city.



See p.102 for the list of cities and code names.

## Screen Effect

When the LCD monitor display switches to another mode, you can apply a transition effect.

- 1** Select [Screen Effect] on the [Set-up] menu.
- 2** Use the four-way controller (◀▶) to select  (On) or  (Off).
- 3** Press the Playback/OK button.  
 The camera is ready to take or play back images.

## How to recall the [Set-up] menu

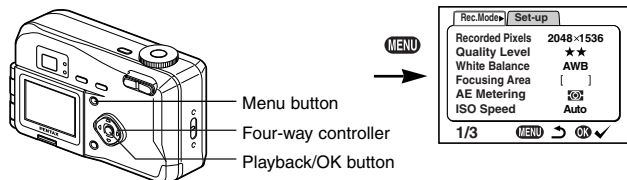

## LCD Power Saving (Sleep Timeout)

You can set the LCD monitor to turn off automatically when no operation is performed for a fixed time.

- 1** Select [Sleep Timeout] on the [Set-up] menu.
- 2** Use the four-way controller (◀ ▶) to select [30s], [1m], [2m] or [OFF].
- 3** Press the Playback/OK button.  
The camera is ready to take or play back images.



- This function will not work in Playback mode and using the USB cable and when the camera is operated by optional AC adapter.

## Auto Power Off Function

The camera turns off automatically when no operation is performed for a set time.



- The camera turns off 3 minutes after the last operation.
- If you do not perform any operation for one minute after the menu is displayed, the menu will be closed.

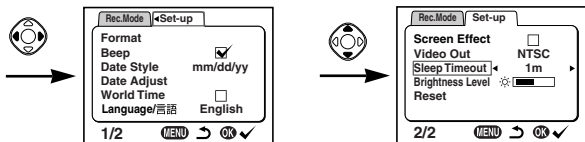

## Setting the Brightness Level

You can set the brightness of the LCD monitor.

- 1 Select [Brightness Level] on the [Set-up] menu.**
- 2 Use the four-way controller (◀ ▶) to select brightness level.**  
Press (◀) to make the LCD monitor darker and press (▶) to make it brighter.
- 3 Press the Playback/OK button.**  
The camera is ready to take or play back images.

## Resetting to Default Settings (Reset)

You can reset all the settings other than the date and time, language, Home Time, alarm and date style.

- 1 Select [Reset] on the [Set-up] menu.**
- 2 Press the four-way controller button (▶).**  
The Reset screen will be displayed.
- 3 Use the four-way controller (▲) to select [Reset].**
- 4 Press the Playback/OK button.**  
The camera is ready to capture or play back images.

# List of City Names

Refer to following list of city and code names for setting the world time.

<b>Code</b>	<b>City names</b>	<b>Code</b>	<b>City names</b>
PPG	Pagopago	THR	Tehran
HNL	Honolulu	DXB	Dubai
ANC	Anchorage	KHL	Karachi
YVR	Vancouver	KBL	Kabul
SFO	San Francisco	MLE	Male
LAX	Los Angeles	DEL	Delhi
YYC	Calgary	CMB	Colombo
DEN	Denver	KTM	Kathmandu
MEX	Mexico City	DAC	Dacca
CHI	Chicago	RGN	Rangoon
MIA	Miami	BKK	Bangkok
YTO	Toronto	KUL	Kuala Lumpur
NYC	New York	VTE	Vientiane
SCL	San Diego	SIN	Singapore
CCS	Caracas	PNH	Phnom Penh
YHZ	Halifax	SGN	Ho chi Minh
BUE	Buenos Aires	JKT	Jakarta
SAO	Sao Paulo	HKG	Hong Kong
RIO	Rio de Janeiro	PER	Perth
MAD	Madrid	BJS	Beijing
LON	London	SHA	Shanghai
PAR	Paris	MNL	Manila
MIL	Milan	TPE	Taipei
ROM	Rome	SEL	Seoul
BER	Berlin	ADL	Adelaide
JNB	Johannesburg	TYO	Tokyo
IST	Istanbul	GUM	Guam
CAI	Cairo	SYD	Sydney
JRS	Jerusalem	NOU	Noumea
MOW	Moscow	WLG	Wellington
JED	Jeddah	AKL	Auckland



# Messages





Messages such as the following may be displayed on the LCD monitor during camera operation.



CF card full	The CF card memory is full and no more images can be saved. Insert a new CF card or delete unwanted images. (p.13, p.74) Change the quality/size and try again. (p.36, p.37)
No image	There are no images on the CF card.
Camera can not display this image.	You are trying to play back an image in a format not supported by this camera. You may be able to display it on another brand of camera or PC.
No card in camera.	There is no CF card in the camera. (p.13)
Battery depleted.	The battery is exhausted. Charge the NiMH batteries using a battery charger or replace with new batteries. (p.10, p.11)
Memory card error.	Shooting and playback are impossible due to a problem with CF card. Try displaying on a PC.
This card is not formatted.	The card you have inserted is unformatted or has been formatted on PC or other device. (p.94)
Image recording...	The image is being recorded on the CF card.
Movie recording...	The movie picture is being recorded on the CF card.
Changing setting	The protect setting or DPOF setting is being changed.
Formatting	The CF card is being formatted.

Deleting	The image is being deleted.
Image folder could not be created.	The largest file number is assigned to an image and no more images can be saved. Insert a new CF card or format the CF card. (p.94)
Setting not stored.	The CF card memory is full and no more DPOF setting can be saved. Return to DPOF setting screen and set DPOF again.

# Troubleshooting

Problem	Cause	Remedy
Power will not come on	Battery is not installed	Check battery is installed. If not, install battery.
	CF card cover is open	Close CF card cover.
	Battery is installed incorrectly	Check orientation of battery. Reinsert battery as indicated by (+) (-) inside the battery chamber. (p.10)
	Battery power is low	Insert a new battery or use the AC adapter.
No image on the LCD monitor	LCD monitor is set to OFF	Press Display button to turn LCD monitor on. (p.48)
	Camera is connected to TV	LCD monitor remains off while camera is connected to TV.
	Image is displayed but is hard to see	Image on LCD monitor may be hard to see when taking pictures outside in sunlight. Adjust the brightness of the LCD monitor. (p.101)
Shutter release button will not release	Flash is charging	When flash lamp blinks red, flash is charging and no pictures can be taken. Lamp lights red when charging is completed.
	No available space on CF card	Insert CF card with available space or delete unwanted images. (p.13, 74)
	Recording	Wait until recording is finished.

Problem	Cause	Remedy
Subject is not in focus	Subject difficult to focus on	Subjects difficult to focus on using autofocus: objects with little contrast (blue sky, white walls, etc.), dark objects, finely patterned objects, fast-moving objects, scenery through window or net, etc. Lock focus on another object located at same distance (press shutter release button halfway), then aim at target and press shutter release button fully.
	Subject is not in focusing area	Position subject in AF frame (focusing area) in middle of LCD monitor. If the subject is outside the focusing area, aim the camera at the subject and lock focus (press shutter release button halfway), then compose picture and press the shutter release button fully.
	Subject is too close	Set focus mode on  . (p.29)
	Focus mode is set on 	Normal pictures will be out of focus if taken with focus mode set on  .
Picture is dark	Subject is too far away in a dark environment, such as a night scene.	Picture becomes dark if subject is too far away. Take picture within range of flash.
	Background is dark	When taking a picture of a person against dark background, such as night scene, the person may appear dark if the flash does not reach background even with correct exposure. Set to  mode to ensure both person and background are clear. (p.52)

Problem	Cause	Remedy
Flash does not fire	Flash mode is set to Off	Set to Auto or  . (p.31)
	The Capture mode is set to  , continuous shooting, or Infinity-landscape mode.	Flash will not fire in these modes.

# Main Specifications

Type	Fully automatic compact-type digital still camera with built-in zoom lens	
Effective Pixels	3.2 megapixels	
Sensor	3.34 megapixels (total pixels) 1/2.7 inch interline transfer CCD with a primary color filter	
Recorded Pixels	Still	2048 × 1536 pixels, 1600 × 1200 pixels, 1024 × 768 pixels, 640 × 480 pixels
	Movie	320 × 240 pixels
Sensitivity	Auto, manual (equivalent to ISO 100, 200, 400)	
File Format	Still	JPEG (Exif2.2), DCF, DPOF, PRINT Image Matching II
	Movie	AVI (Motion JPEG), 15fps
Quality Level	"Good", "Better", "Best"	
Storage Medium	CompactFlash (CF) card Type I	

## Image Storage Capacity

Quality levels Recorded pixels	Best (★★★)	Better (★★)	Good (★)	Movie images (320 × 240)
2048 × 1536	Approx.8	Approx.16	Approx.33	30 sec. × 2 sets
1600 × 1200	Approx.13	Approx.27	Approx.60	
1024 × 768	Approx.24	Approx.50	Approx.89	
640 × 480	Approx.50	Approx.89	Approx.128	

- Exposure capacity when using a 16MB CF card

White Balance	Auto, Daylight, Shade, Tungsten Light, Fluorescent Light, Manual	
Color Modes	Color, B&W, Sepia	
Lens	Focal Length	5.8 mm-17.4 mm (Equivalent to 38 mm-114 mm in 35 mm format)
	Aperture	F2.6-F5.0
	Lens Composition	6 elements in 5 groups (one aspherical element)
	Zoom type	Electrically driven
	Picture Range	38.4 mm × 28.5 mm (screen is filled) (using macro mode or manual focus at max, WIDE position)
	Lens Barrier	Electrically driven
Digital Zoom	Capture mode	Max. 2.7x (Combines with 3x optical zoom to give zoom magnification equivalent to 8x)
Viewfinder	Type	Real-image zoom viewfinder
	Magnification	Wide 0.41x, Tele 1.13x

LCD Monitor	1.6 inch TFD color LCD monitor (with backlight/brightness adjustment) With 180° swing out function	
Playback Function	Single-frame, 9-frame index, enlargement (max. 12x), scroll, slideshow, movie playback	
Focusing System	Type	TTL contrast detection autofocus system
	Focusing Range (From lens front)	Normal : 0.4m (1.31 ft) to infinity (zoom fully extended) Macro : 0.1 m (0.33 ft)–0.5 m (1.64 ft) (full zoom range) Landscape : Infinity (zoom fully extended)
	Focus Lock	By half-pressing shutter release button
Manual Focus	0.1m to infinity	
Exposure Mechanism	AE Metering	TTL metering by sensor (Multi-segment, Center-weighted, Spot)
	Exposure Modes	Standard, PICT, Night Scene, Movie, 3D image
	Exposure Compensation	±2 EV (Set in 1/3 EV steps)
	Movie	Recording time approx. 1 sec–30 sec.
Shutter	Type	Electronic/mechanical shutter
	Speed	Approx. 1/1500 sec.–4 sec.
Flash	Type	Auto flash with red-eye reduction function
	Flash Modes	Auto, Flash Off, Flash On, Auto + Red-eye reduction, Flash On + Red-eye Reduction
	Working Range	Wide Approx. 0.2m–5.0m (0.66ft–16ft) at 5.8m w/ISO AUTO Tele Approx. 0.1m–2.7m (0.33ft–8.9ft) at 7.4m w/ISO AUTO
Drive Modes	Single-frame, Continuous, Self-timer	
Self-timer	Electronic control type, delay time: approx. 10 sec.	
Time function	World Time setting for 62 cities (28 time zones)	
Power Supply	One CR-V3 lithium battery pack, two R6/AA batteries (Alkaline, NIMH, lithium), AC adapter (optional)	
Number of recordable images	Approx. 500 with the flash fired for 50% of the shots, LCD monitor ON (Tested with CR-V3 lithium battery pack) in accordance with Pentax measuring conditions.	
In/Out Port	USB/Video terminal (PC communication type USB1.1), external power supply terminal	
Video Output Format	NTSC, PAL	
Size	103.5(W) x 63.5(H) x 42(D) mm (excluding operating members)	
Weight	180 g (excluding batteries and CF card)	
Weight when shooting	230 g (including battery and CF card)	
Accessories	CR-V3 lithium battery pack, 3D image viewer, USB cable, software (CD-ROM), video cable, strap, operating manual	

## Optional Accessories

A number of dedicated accessories are available for this camera.

- AC adapter ( D-AC5)
- AC Plug Cord
  - D-CO2A Australia
  - D-CO2B United Kingdom
  - D-CO2E Europe
  - D-CO2H Hong Kong
  - D-CO2J Japan
  - D-CO2K Korea
  - D-CO2U North America, Canada
- USB Cable (I-USB2)
- Video Cable (I-VC2)
- Camera Case (O-CC5)
- Strap (O-ST5)
- 3D image viewer (O-3DV1)



# WARRANTY POLICY

All Pentax cameras purchased through authorized bona fide photographic distribution channels are guaranteed against defects of material or workmanship for a period of twelve months from date of purchase. Service will be rendered, and defective parts will be replaced without cost to you within that period, provided the equipment does not show evidence of impact, sand or liquid damage, mishandling, tampering, battery or chemical corrosion, operation contrary to operating instructions, or modification by an unauthorized repair shop. The manufacturer or its authorized representatives shall not be liable for any repair or alterations except those made with its written consent and shall not be liable for damages from delay or loss of use or from other indirect or consequential damages of any kind, whether caused by defective material or workmanship or otherwise; and it is expressly agreed that the liability of the manufacturer or its representatives under all guarantees or warranties, whether expressed or implied, is strictly limited to the replacement of parts as hereinbefore provided. No refunds will be made on repairs by non-authorized Pentax service facilities.

## Procedure During 12-month Warranty Period

Any Pentax which proves defective during the 12-month warranty period should be returned to the dealer from whom you purchased the equipment or to the manufacturer. If there is no representatives of the manufacturer in your country, send the equipment to the manufacturer, with postage prepaid. In this case, it will take a considerable length of time before the equipment can be returned to you owing to the complicated customs procedures required. If the equipment is covered by warranty, repairs will be made and parts replaced free of charge, and the equipment will be returned to you upon completion of servicing. If the equipment is not covered by warranty, regular charges of the manufacturer or of its representatives will apply. Shipping charges are to be borne by the owner. If your Pentax was purchased outside of the country where you wish to have it serviced during the warranty period, regular handling and servicing fees may be charged by the manufacturer's representatives in that country. Notwithstanding this, your Pentax returned to the manufacturer will be serviced free of charge according to this procedure and warranty policy. In any case, however, shipping charges and customs clearance fees to be borne by the sender. To prove the date of your purchase when required, please keep the receipt or bills covering the purchase of your equipment for at least a year. Before sending your equipment for servicing, please make sure that you are sending it to the manufacturer's authorized representatives or their approved repair shops, unless you are sending it directly to the manufacturer. Always obtain a quotation for the service charge, and only after you accept the quoted service charge, instruct the service station to proceed with the servicing.

- **This warranty policy does not affect the customer's statutory rights.**
- **The local warranty policies available from Pentax distributors in some countries can supersede this warranty policy. Therefore, we recommend that you review the warranty card supplied with your product at the time of purchase, or contact the PENTAX distributor in your country for more**

information and to receive a copy of the warranty policy.

## **For customers in USA**

### **STATEMENT OF FCC COMPLIANCE**

This device complies with Part 15 of the FCC Rules. Operation is subject to the following two conditions: (1) This device may not cause harmful interference, and (2) this device must accept any interference received, including interference that may cause undesired operation. Changes or modifications not approved by the party responsible for compliance could void the user's authority to operate the equipment. This equipment has been tested and found comply with the limits for a Class B digital device, pursuant to part 15 of the FCC Rules. These limits are designed to provide reasonable protection against harmful interference in a residential installation. This equipment generates, uses and can radiate frequency energy and, if not installed and used in accordance with the instructions, may cause harmful interference to radio communications. However, there is no guarantee that interference will not occur in a particular installation. If this equipment does cause harmful interference to radio or television reception, which can be determined by turning the equipment off and on, the user is encouraged to try to correct the interference by one or more of the following measures:

- Reorient or relocate the receiving antenna.  
Increase the separation between the equipment and receiver.  
Connect the equipment into an outlet on a circuit different from that to which the receiver is connected.
- \* Consult the dealer or an experienced radio/TV technician for help.

## **For customers in Canada**

This Class B digital apparatus meets all requirements of the Canadian Interference - Causing Equipment Regulations.

### **Pour les utilisateurs au Canada**

Cet appareil numérique de la classe B respecte toutes les exigences du Règlement sur le matériel brouilleur du Canada.



The CE Mark is a Directive conformity mark of the European Community.

## Declaration of Conformity

According to 47CFR, Parts 2 and 15 for  
Class B Personal Computers and Peripherals

We: PENTAX U.S.A., Inc.

Located at: 35 Inverness Drive East  
Englewood, Colorado 80112 USA  
Phone: 303-799-8000 FAX: 303-790-1131

Declare under sole responsibility that the product identified herein, complies with 47CFR Parts 2 and 15 of the FCC rules as a Class B digital device. Each product marketed, is identical to the representative unit tested and found to be compliant with the standards. Records maintained continue to reflect the equipment being produced can be expected to be within the variation accepted, due to quantity production and testing on the statistical basis as required by 47CFR §2.909. Operation is subject to the following two conditions: (1) This device may not cause harmful interference, and (2) This device must accept any interference received, including interference that may cause undesired operation. The above named party is responsible for ensuring that the equipment complies with the standards of 47CFR §15.101 to §15.109.

Product Name: PENTAX Digital Still Camera

Model Number: Optio 330GS

Contact person: Customer Service Manager

Date and Place: September, 2002, Colorado

**PENTAX Corporation Ltd.**

2-36-9, Maeno-cho, Itabashi-ku, Tokyo 174-8639,  
JAPAN  
(<http://www.pentax.co.jp/>)

**PENTAX EUROPE GmbH (European Headquarters)**

Julius-Vosseler-Strasse, 104, 22527 Hamburg,  
GERMANY  
(HQ - <http://www.pentaxeuropa.com>)  
(Germany - <http://www.pentax.de>)

**Pentax U.K. Limited**

Pentax House, Heron drive, Langley, Slough, Berks  
SL3 8PN, U.K.  
(<http://www.pentax.co.uk>)

**Pentax France S.A.**

12/14, rue Jean Poulmarch, 95106 Argenteuil Cedex,  
FRANCE

**Pentax Benelux B.V.**

(for Netherlands)  
Spinveld 25, 4815 HR Breda, NETHERLANDS  
(<http://www.pentax.nl>)  
(for Belgium & Luxembourg)  
Weiveldlaan 3-5, 1930 Zaventem, BELGIUM  
(<http://www.pentax.be>)

**Pentax (Schweiz) AG**

Widenholzstrasse 1 Postfach 367 8305 Dietlikon,  
SWITZERLAND  
(<http://www.pentax.ch>)

**Pentax Scandinavia AB**

P.O. Box 650, 75127 Uppsala, SWEDEN  
(<http://www.pentax.se>)

**PENTAX U.S.A., Inc**

35 Inverness Drive East, Englewood, Colorado  
80112, U.S.A.  
(<http://www.pentax.com>)

**Pentax Canada Inc.**

3131 Universal Drive, Mississauga, Ontario L4X 2E5,  
CANADA  
(<http://www.pentaxcanada.ca>)

<http://www.digital.pentax.co.jp>

- Printed on recycled paper
- Specifications and external dimensions are subject to change without notice.